



make it **happen**

Aspire Trade Guide.

January 2025

Extensive range of
board. doors. fittings for furniture





Contents.

04	A Unique Choice
06	Décors
06	Woodgrain
07	High Gloss
08	Painted Oak, Uni-Colour & Material
09	Super Matt
10	Door Styles Overview
12	Décors - Board Match
14	Mouldings
18	Door Specification Pages
79	Ordering Drawer Fronts & Bi-Fold Doors
80	Inset Handle Doors
81	Glazing & Drilling
82	Kitchen Accessories
84	Bedroom Accessories
86	Tips & Technical Help

Unique Choice.

Our Brand For Your Customers

- 6 Year Guarantee On All AUC Products
- Desktop, Tablet & Mobile Friendly Website
- A Brand You Can Sell To Your Customers
- Full Range Of Marketing Materials
- Kitchen & Bedroom Brochures

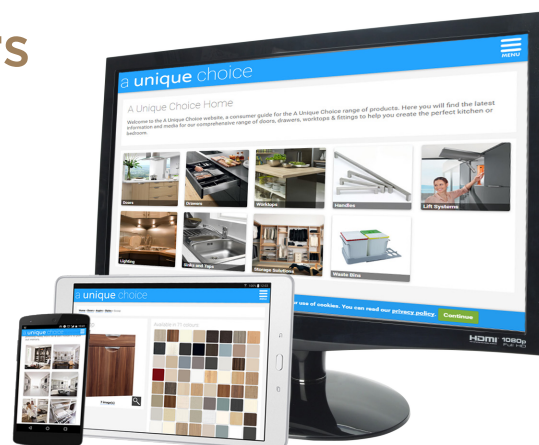

“As HPP is a trade only company we have decided to refresh the ‘A Unique Choice’ brand and separate what we do from what you do.”



Handle Range Brochure

Featuring HPP's complete & comprehensive handle & worktop ranges, this 'A Unique Choice' branded brochure is designed with your customers in mind. Visit www.hpponline.co.uk/a-unique-choice for more info and to order your copies today.



Visit www.hpponline.co.uk/a-unique-choice for more information & to request your brochures

Unique Choice.



Kitchen & Bedroom Brochures

Comfortably our biggest ever consumer facing brochures, they include our full range of Aspire vinyl wrapped door styles & décors. They also include a select range of other products that we feel your customers would like to consider.

Vinyl Wrapped Door Visualiser

The vinyl door visualiser allows you to view any style & décor pairing to help you choose the right combination. Select any door styles then choose your vinyl décor and the visualiser will display a preview for you to either view or save and present to your customer.

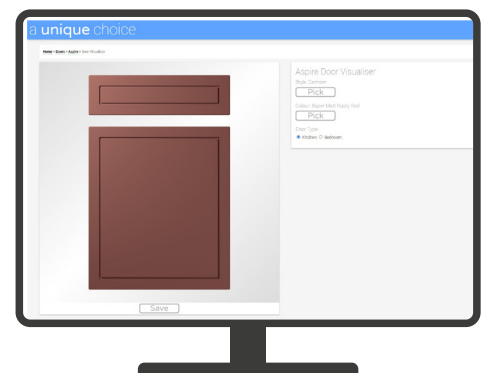

6 Year Guarantee

For your peace of mind and to further reinforce your customer's confidence, we offer a 6 Year Guarantee on all of the products featured in the brochures which we feel helps to create a very strong proposition for you during the selling process.

www.auniquechoice.co.uk

The 'A Unique Choice' website has been completely redesigned. It is now easy to use, easy to navigate, mobile friendly and completely HPP unbranded. This means you can use it to demonstrate to your customers the wide range of products you have to offer them.

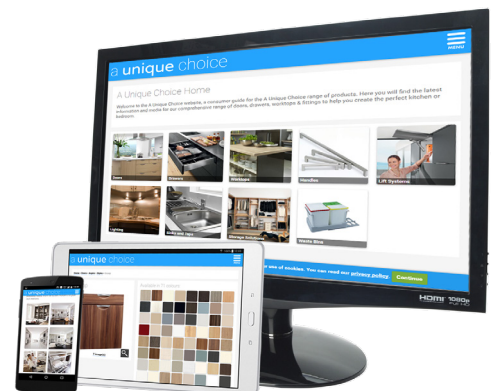

Everything You Need To Help You Sell

Woodgrain Décors



Coast Evoke Oak



Driftwood



Ellmau Beech



Lancaster Oak



Lissa Oak



Moldau Acacia

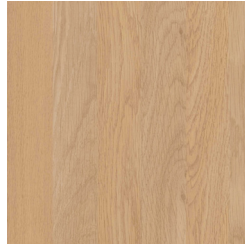

Montana Oak



Natural Aida Walnut



Opera Walnut



Sonoma Oak



Winchester Oak

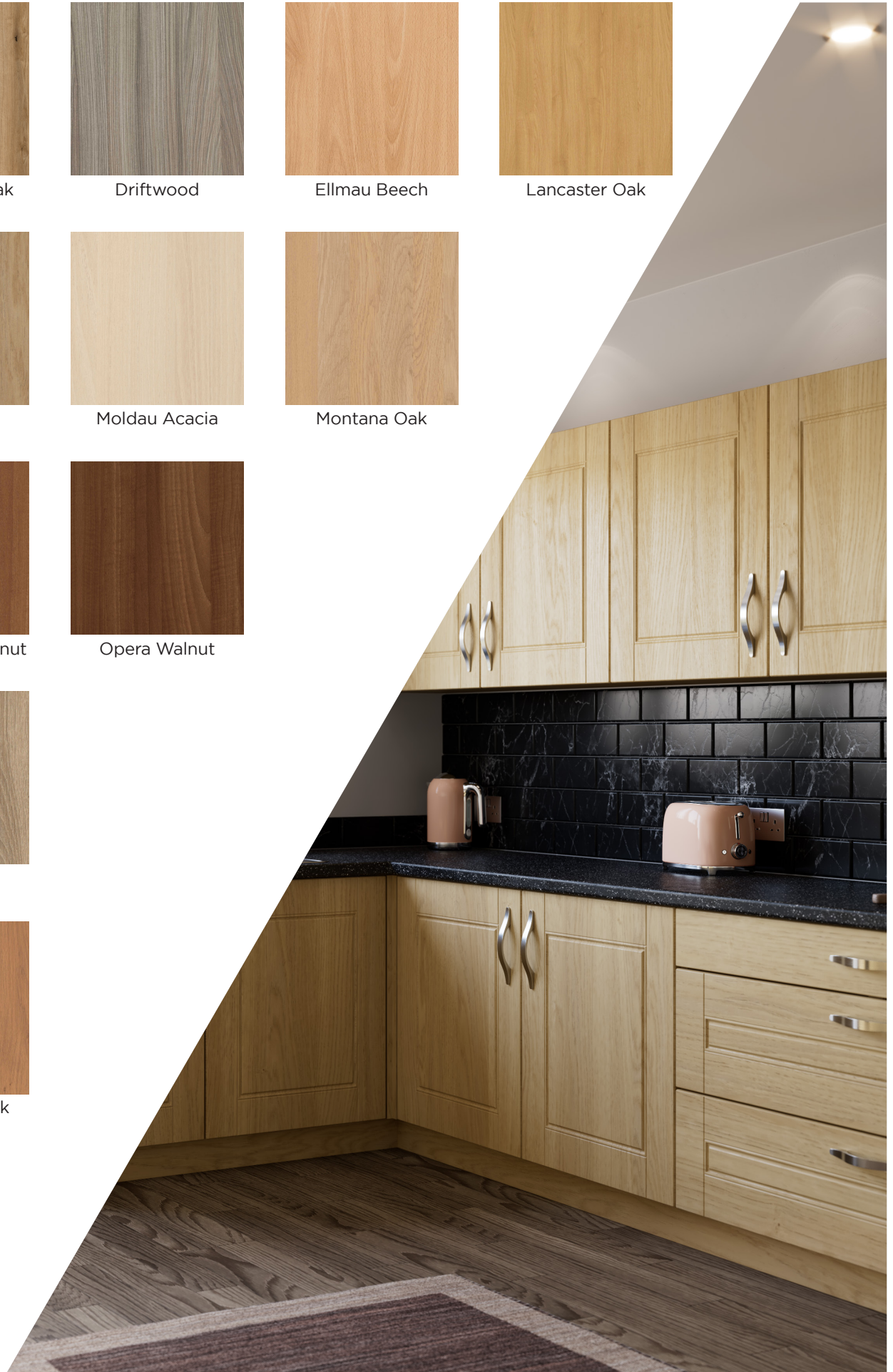

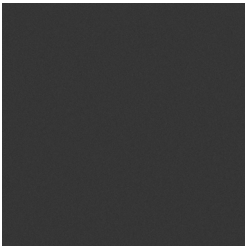

High Gloss
Anthracite



High Gloss
Cashmere

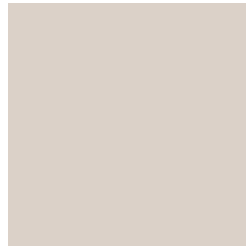

High Gloss Cream



High Gloss Denim

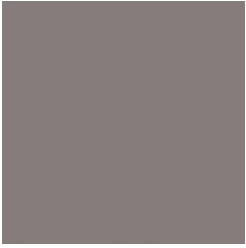

High Gloss Dust
Grey

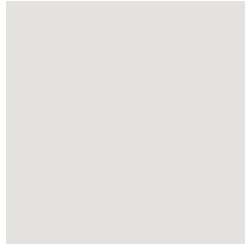

High Gloss Grey

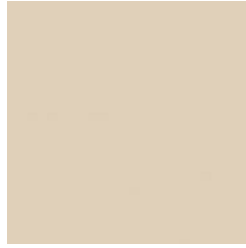

High Gloss Mussel

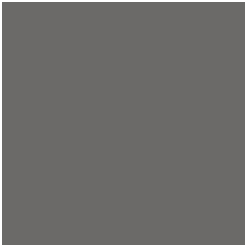

High Gloss Onyx
Grey

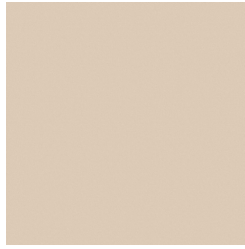

High Gloss Sand
Beige

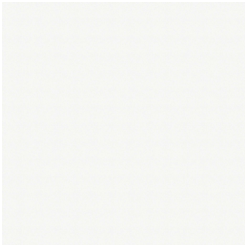

High Gloss White

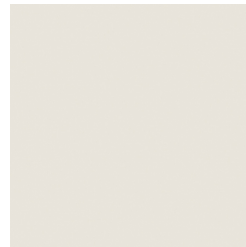

High Gloss White
Grey





Dakar



Ivory

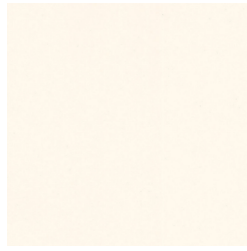

Pale Cream

Painted Oak Effect Décors



Painted Oak
Alby Blue



Painted Oak
Cashmere

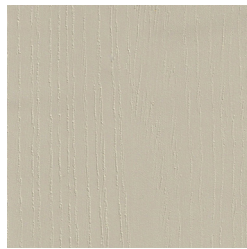

Painted Oak
Dakar

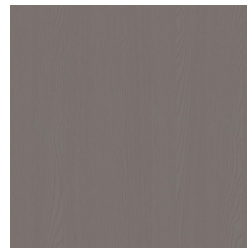

Painted Oak
Dust Grey



Painted Oak
Ivory

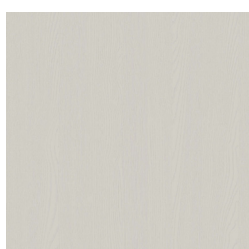

Painted Oak
Light Grey



Painted Oak
Mussel



Painted Oak
Porcelain



Painted Oak
Reed Green



Painted Oak
White





Super Matt
Alby Blue

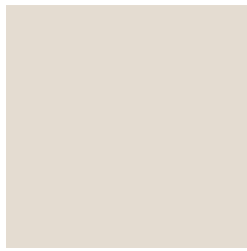

Super Matt
Angora Grey



Super Matt
Black



Super Matt
Cashmere



Super Matt
Denim

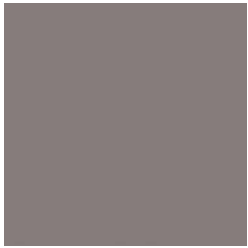

Super Matt
Dust Grey



Super Matt
Fjord



Super Matt
Frost White



Super Matt
Graphite

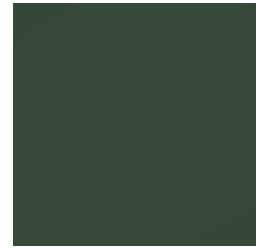

Super Matt
Highland Green



Super Matt
Indigo Blue



Super Matt Kobe
(Dusky Pink)

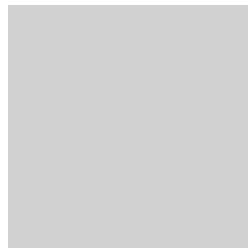

Super Matt
Light Grey

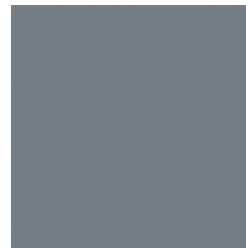

Super Matt
Monument Grey

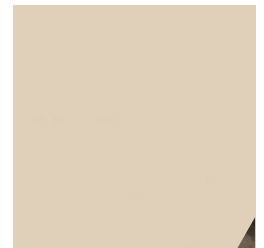

Super Matt
Mussel



Super Matt
Onyx Grey



Super Matt
Reed Green

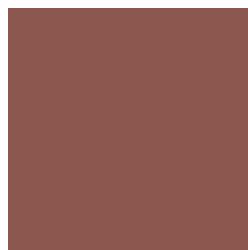

Super Matt
Rusty Red

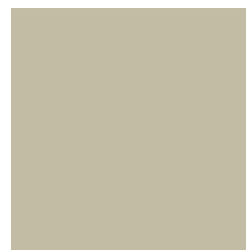

Super Matt
Sage Green

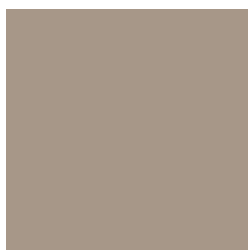

Super Matt
Stone Grey

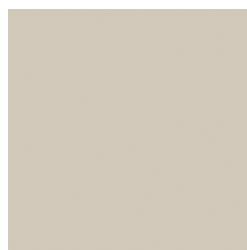

Super Matt
Taupe Grey

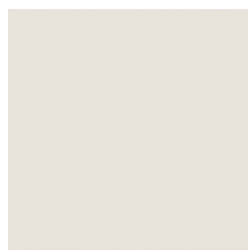

Super Matt
White Grey



Door Collection



Ascot	Avienda	Balmoral	Belize	Benwick	Boston	Brecon	Bridgewater
P	S	W P	S	S	S	S	P
Page 18	Page 19	Page 20	Page 21	Page 22	Page 23	Page 24	Page 25
Crossland	Denham	Denver	Esquire	Fenwick	Florence	Genoa	Grove
S	S	P	S	S	S	S	S
Page 34	Page 35	Page 36	Page 37	Page 38	Page 39	Page 40	Page 41
Keswick	Linea	Madrid	Manhattan	Mercia	Mersey	Metropole	Milano
P	S	S	S	P	S	S	S
Page 50	Page 51	Page 52	Page 53	Page 54	Page 55	Page 56	Page 57
Sahara	Scoop	Severn	Shaker	Sutton	Treviso	Turin	Twinline
P	S	S	P	P	P	S	S
Page 66	Page 67	Page 68	Page 69	Page 70	Page 71	Page 72	Page 73

Brockworth



Page 26

Camden



Page 27

Caraway

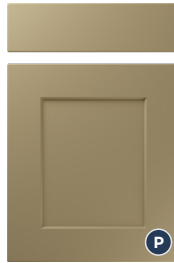

Page 28

Chardonnay



Page 29

Chedburgh



Page 30

Coniston



Page 31

Cordoba

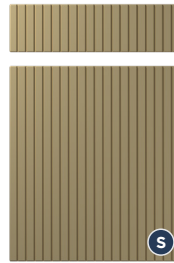

Page 32

Cottage



Page 33

Halstead



Page 42

Havana



Page 43

Henlow



Page 44

Hudson



Page 45

Johnson



Page 46

Juliette



Page 47

Kelby



Page 48

Kendal



Page 49

New England



Page 58

New Fenland



Page 59

New Sudbury



Page 60

Nova



Page 61

Oslo



Page 62

Palermo



Page 63

Pillow



Page 64

Ribble



Page 65

Valencia



Page 74

Verona



Page 75

Vienna



Page 76

Willingdale



Page 77

Winwick



Page 78

- P** Premium Door Style
- S** Standard Door Style
- W** 22mm Thickness & White Back

Décor - Board Match



Décor	Backing	Egger	Kronospan	Pre Glued Edging
Coast Evoke Oak	Matching		K365	
Dakar	Matching	U717		EDU717
Driftwood	Matching	H3090		EDH3090
Ellmau Beech	Matching	H1582		EDH1582
High Gloss Anthracite	Matching	U961		EDU961
High Gloss Cashmere	Matching	U702	5981	EDU702ST9
High Gloss Cream	Matching		0564	EDD564
High Gloss Denim	Matching	U540		
High Gloss Dust Grey	Matching	U732		EDU732
High Gloss Grey	Matching	U708	0112	EDD112BF
High Gloss Mussel	Matching	U100	5982	EDU100
High Gloss Onyx Grey	Matching	U960		EDU960ST9
High Gloss Sand Beige	Matching	U156		EDU156
High Gloss White	Matching	W1000	0101	EDSE1-01
High Gloss White Grey	Matching	U775		EDU775ST9
Ivory	Matching	U104	0514	EDU514BF
Lancaster Oak	Matching		8925	EDD8925
Lissa Oak	Matching	H1154	8925	EDH1277
Moldau Acacia	Matching	H1277		EDH1342
Montana Oak	Matching	H1342	1929	EDD726
Natural Aida Walnut	Matching	H3703	0726	EDD481
Opera Walnut	Matching	H3704	0481	
Painted Oak Alby Blue	Matching (Matt with no grain)		5994GC	EDU702ST27100M
Painted Oak Cashmere	Matching (Matt with no grain)	U702ST12 or U702ST40	5981GC	EDU717ST27
Painted Oak Dakar	Matching (Matt with no grain)	U717ST12 or U717ST40	5984GC	EDU732
Painted Oak Dust Grey	Matching (Matt with no grain)	U732ST12 or U732ST40		EDU104ST27
Painted Oak Ivory	Matching (Matt with no grain)	U104ST12 or U104ST40	7031GC	EDU708ST27
Painted Oak Light Grey	Matching (Matt with no grain)	U708ST12 or U708ST40	0112GC	EDU100ST27
Painted Oak Mussel	Matching (Matt with no grain)	U100ST12 or U100ST40	5982GC	EDW1200ST27
Painted Oak Porcelain	Matching (Matt with no grain)	W1200ST12 or W1200ST40		EDU604
Painted Oak Reed Green	Matching (Matt with no grain)	U604ST40		EDW980ST27

Décor	Backing	Egger	Kronospan	Pre Glued Edging
Painted Oak White	Matching (Matt with no grain)		0101GC	EDD564
Pale Cream	Matching		0564	EDH1146
Sonoma Oak	Matching	H1146	8197	
Super Matt Alby Blue	Matching		5994	
Super Matt Angora Grey	Matching	U705		EDU961
Super Matt Black	Matching	U899		EDU702ST9
Super Matt Cashmere	Matching	U702	5981	
Super Matt Denim	Matching	U540		EDU732
Super Matt Dust Grey	Matching	U732		EDU636
Super Matt Fjord	Matching	U636		EDW1100ST9
Super Matt Frost White	Matching	W1100		EDU961
Super Matt Graphite	Matching	U961		
Super Matt Highland Green	Matching	U665		
Super Matt Indigo Blue	Matching	U599		
Super Matt Kobe (Dusky Pink)	White	U325		EDD112BF
Super Matt Light Grey	Matching	U708	0112	EDU780ST9
Super Matt Monument Grey	Matching	U780		EDU100
Super Matt Mussel	Matching	U100	5982	EDU960ST9
Super Matt Onyx Grey	Matching	U960		EDU604
Super Matt Reed Green	Matching	U604		
Super Matt Rusty Red	Matching	U335		
Super Matt Sage Green	Matching	U638		EDU727
Super Matt Stone Grey	Matching	U727	K096 SU	EDU750ST9
Super Matt Taupe Grey	Matching	U750		EDU775ST9
Super Matt White Grey	Matching	U775		EDH1381
Winchester Oak	Matching	H1381	9277	

Mouldings Matrix



Décor	Peel & Stick Vinyl	Dual Purpose Moulding	Round Bullnose	Pelmet	Cornice	Square Bullnose	Rounded Pilaster
		3.0m	3.0m	3.0m	3.0m	3.0m	3.0m
Coast Evoke Oak	✓	×	×	2.4m To Order	2.4m To Order	✓	2.4m To Order
Dakar	✓	×	✓	2.4m To Order	2.4m To Order	2.4m To Order	2.4m To Order
Driftwood	✓	×	✓	2.4m To Order	2.4m To Order	2.4m To Order	2.4m To Order
Ellmau Beech	✓	×	✓	2.4m To Order	2.4m To Order	2.4m To Order	2.4m To Order
High Gloss Anthracite	✓	✓	×	2.4m To Order	2.4m To Order	2.4m To Order	2.4m To Order
High Gloss Cashmere	✓	✓	×	2.4m To Order	2.4m To Order	✓	2.4m To Order
High Gloss Cream	✓	✓	✓	2.4m To Order	2.4m To Order	✓	2.4m To Order
High Gloss Denim	✓	✓	×	2.4m To Order	2.4m To Order	2.4m To Order	2.4m To Order
High Gloss Dust Grey	✓	✓	×	2.4m To Order	2.4m To Order	✓	2.4m To Order
High Gloss Grey	✓	✓	✓	2.4m To Order	2.4m To Order	✓	2.4m To Order
High Gloss Mussel	✓	✓	×	2.4m To Order	2.4m To Order	✓	2.4m To Order
High Gloss Onyx Grey	✓	×	×	2.4m To Order	2.4m To Order	✓	2.4m To Order
High Gloss Sand Beige	✓	✓	✓	2.4m To Order	2.4m To Order	2.4m To Order	2.4m To Order
High Gloss White	✓	✓	✓	✓	✓	✓	2.4m To Order
High Gloss White Grey	✓	×	×	2.4m To Order	2.4m To Order	✓	2.4m To Order
Ivory	✓	×	✓	✓	✓	✓	2.4m To Order
Lancaster Oak	✓	×	✓	✓	✓	2.4m To Order	2.4m To Order
Lissa Oak	✓	×	✓	✓	✓	2.4m To Order	2.4m To Order
Moldau Acacia	✓	×	✓	2.4m To Order	2.4m To Order	2.4m To Order	2.4m To Order
Montana Oak	✓	×	✓	2.4m To Order	2.4m To Order	2.4m To Order	2.4m To Order
Natural Aida Walnut	✓	×	✓	2.4m To Order	2.4m To Order	2.4m To Order	2.4m To Order
Opera Walnut	✓	×	×	2.4m To Order	2.4m To Order	2.4m To Order	2.4m To Order
Painted Oak Alby Blue	✓	×	×	2.4m To Order	2.4m To Order	✓	2.4m To Order
Painted Oak Cashmere	✓	×	✓	✓	✓	✓	2.4m To Order
Painted Oak Dakar	✓	×	✓	✓	✓	2.4m To Order	2.4m To Order
Painted Oak Dust Grey	✓	✓	×	2.4m To Order	2.4m To Order	✓	2.4m To Order
Painted Oak Ivory	✓	×	✓	✓	✓	✓	2.4m To Order
Painted Oak Light Grey	✓	✓	×	✓	✓	✓	2.4m To Order
Painted Oak Mussel	✓	✓	✓	✓	✓	✓	2.4m To Order
Painted Oak Porcelain	✓	✓	×	2.4m To Order	2.4m To Order	✓	2.4m To Order
Painted Oak Reed Green	✓	×	×	2.4m To Order	2.4m To Order	✓	2.4m To Order
Painted Oak White	✓	×	✓	✓	✓	2.4m To Order	2.4m To Order
Pale Cream	✓	×	✓	✓	✓	2.4m To Order	2.4m To Order

Mouldings Matrix

Décor	Peel & Stick Vinyl	Dual Purpose Moulding 3.0m	Round Bullnose 3.0m	Pelmet 3.0m	Cornice 3.0m	Square Bullnose 3.0m	Rounded Pilaster 3.0m
Sonoma Oak	✓	×	✓	2.4m To Order	2.4m To Order	2.4m To Order	2.4m To Order
Super Matt Alby Blue	✓	×	×	2.4m To Order	2.4m To Order	✓	2.4m To Order
Super Matt Angora Grey	✓	×	×	2.4m To Order	2.4m To Order	✓	2.4m To Order
Super Matt Black	✓	×	×	2.4m To Order	2.4m To Order	✓	2.4m To Order
Super Matt Cashmere	✓	✓	×	2.4m To Order	2.4m To Order	✓	2.4m To Order
Super Matt Denim	✓	×	×	2.4m To Order	2.4m To Order	✓	2.4m To Order
Super Matt Dust Grey	✓	✓	×	2.4m To Order	2.4m To Order	✓	2.4m To Order
Super Matt Fjord	✓	✓	×	2.4m To Order	2.4m To Order	2.4m To Order	2.4m To Order
Super Matt Frost White	✓	✓	✓	✓	✓	✓	2.4m To Order
Super Matt Graphite	✓	✓	×	2.4m To Order	2.4m To Order	✓	2.4m To Order
Super Matt Highland Green	✓	×	×	2.4m To Order	2.4m To Order	✓	2.4m To Order
Super Matt Indigo Blue	✓	×	×	2.4m To Order	2.4m To Order	✓	2.4m To Order
Super Matt Kobe (Dusky Pink)	✓	×	×	2.4m To Order	2.4m To Order	2.4m To Order	2.4m To Order
Super Matt Light Grey	✓	✓	×	✓	✓	✓	2.4m To Order
Super Matt Monument Grey	✓	×	×	2.4m To Order	2.4m To Order	✓	2.4m To Order
Super Matt Mussel	✓	✓	×	✓	✓	✓	2.4m To Order
Super Matt Onyx Grey	✓	×	×	2.4m To Order	2.4m To Order	✓	2.4m To Order
Super Matt Reed Green	✓	×	×	2.4m To Order	2.4m To Order	✓	2.4m To Order
Super Matt Rusty Red	✓	×	×	2.4m To Order	2.4m To Order	✓	2.4m To Order
Super Matt Sage Green	✓	×	×	2.4m To Order	2.4m To Order	✓	2.4m To Order
Super Matt Stone Grey	✓	×	×	2.4m To Order	2.4m To Order	2.4m To Order	2.4m To Order
Super Matt Taupe Grey	✓	×	×	2.4m To Order	2.4m To Order	✓	2.4m To Order
Super Matt White Grey	✓	×	×	2.4m To Order	2.4m To Order	✓	2.4m To Order
Winchester Oak	✓	×	✓	✓	✓	2.4m To Order	2.4m To Order

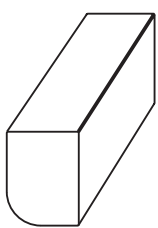

Dual Purpose

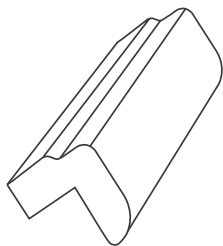

Round Bullnose

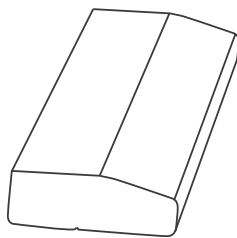

Pelmet

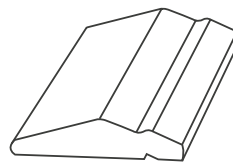

Cornice

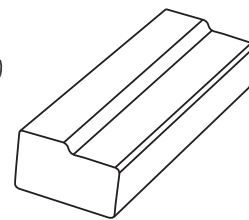

Square Bullnose

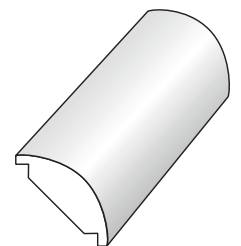

Rounded Pilaster

Square Bullnose Cornice All Moulding Product Codes Starting **SBC**

— Vinyl Wrapped
- - - Bare MDF

3.0m Stacked Components

2.4m Manufactured Components

Pelmet All Moulding Product Codes Starting **L**

— Vinyl Wrapped
- - - Bare MDF

3.0m Stacked Components

2.4m Manufactured Components

Cornice All Moulding Product Codes Starting **C**

— Vinyl Wrapped
- - - Bare MDF

3.0m Stacked Components

2.4m Manufactured Components

Aspects Moulding All Moulding Product Codes Starting **DUOC**

Only available in High Gloss Black & High Gloss White

Round Bullnose Cornice All Moulding Product Codes Starting **RBC**

— Vinyl Wrapped
- - - Bare MDF

3.0m Stacked Components

Rounded Pilaster Available in 2.4m Vinyl Wrapped Only

2.4m Manufactured Components

— Vinyl Wrapped
- - - Bare MDF

Dual Purpose Cornice All Moulding Product Codes Starting **DP**

— Vinyl Wrapped
- - - Bare MDF

3.0m Stacked Components



make it happen

Tel: 0161 628 1147
Email: info@hpponline.co.uk

Hill's Panel Products Ltd. Scottfield Road
Oldham, Lancs, OL8 1LA

f @ in v
hpponline.co.uk





P Premium Door Style

Ascot Door Specification

All drawer fronts horizontal grain	✓
Offset panel doors	✗
Triple porthole doors	✗
Matching panels	✓
Angled & truncated doors	✓
Special sizes	✓
Matching kitchen accessories	✓
Matching bedroom accessories	✓
Cornice, pelmet & plinth	✓

Style Variations

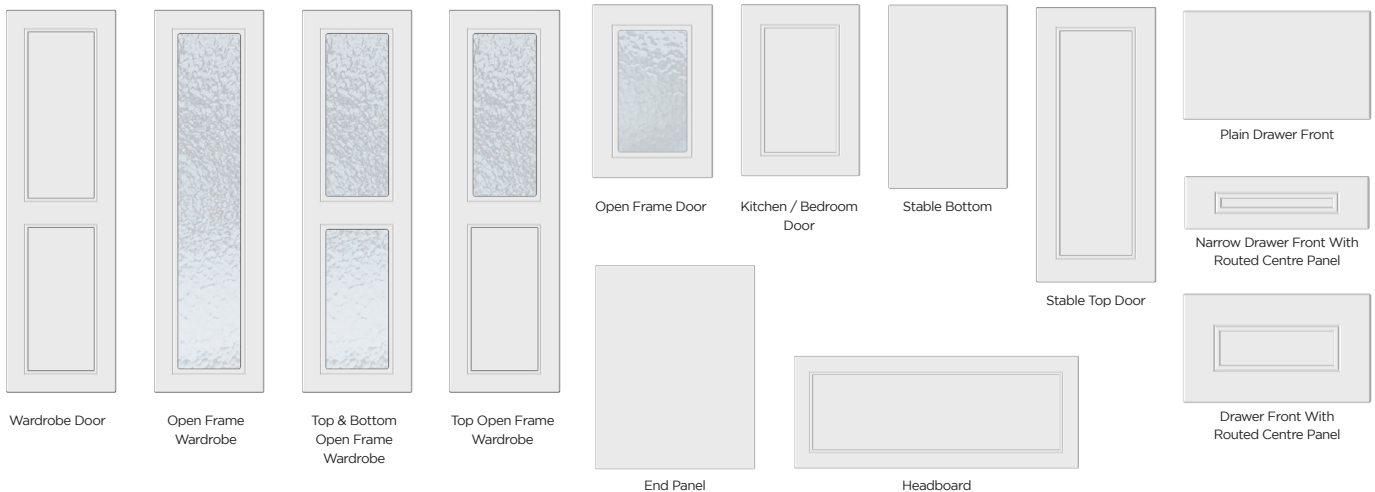

PLAIN OR ROUTED DRAWER FRONTS

If you would like a routed centre panel in your drawers, please specify **“Drawer With Centre Panel”** or **“Narrow Drawer With Centre Panel”** when ordering or choose the appropriate option when ordering online.

Minimum & Maximum Dimensions

Description	Min Height	Max Height	Min Width	Max Width	Notes
Drawer With Centre Panel	241mm	355mm	230mm	1196mm	
Narrow Drawer With Centre Panel	140mm	355mm	230mm	1196mm	Narrow top and bottom stiles (40mm)
Drawer No Centre Panel	100mm	355mm	140mm	1196mm	
Door	285mm	2530mm	100mm	1196mm	Plain panel when width is less than 230mm



S Standard Door Style

Avienda Door Specification

All drawer fronts horizontal grain	✓
Offset panel doors	✓
Triple porthole doors	✓
Matching panels	✓
Angled & truncated doors	✓
Special sizes	✓
Matching kitchen accessories	✓
Matching bedroom accessories	✓
Cornice, pelmet & plinth	✓

Style Variations

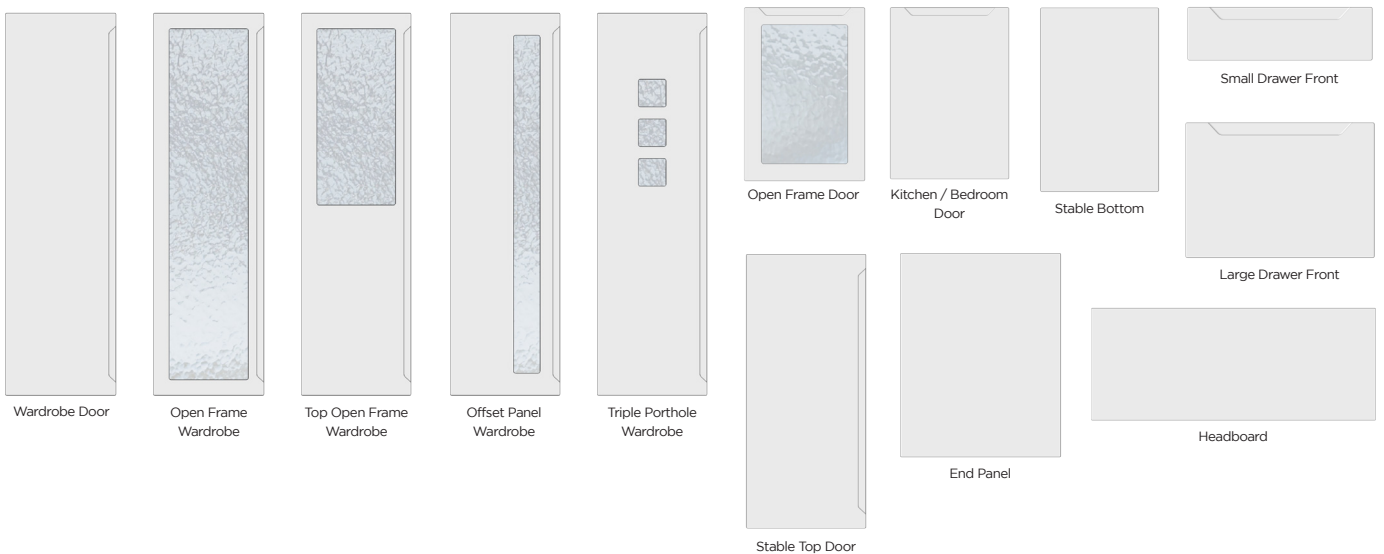

Minimum & Maximum Dimensions

Description	Min Height	Max Height	Min Width	Max Width	Notes
Drawer	100mm	355mm	246mm	1196mm	
Door	285mm	1700mm	246mm	1196mm	

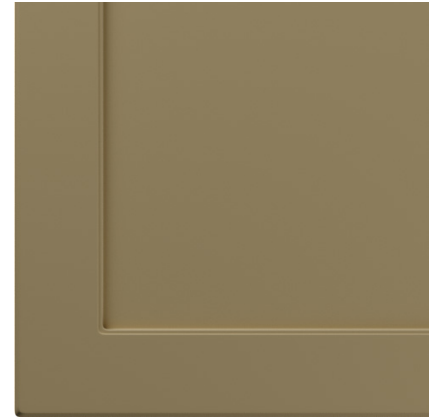

- P** Premium Door Style
- W** 22mm Thickness & White Back

Balmoral Door Specification

All drawer fronts horizontal grain	✓
Offset panel doors	✗
Triple porthole doors	✗
Matching panels	✓
Angled & truncated doors	✓
Special sizes	✓
Matching kitchen accessories	✓
Matching bedroom accessories	✓
Cornice, pelmet & plinth	✓

Style Variations

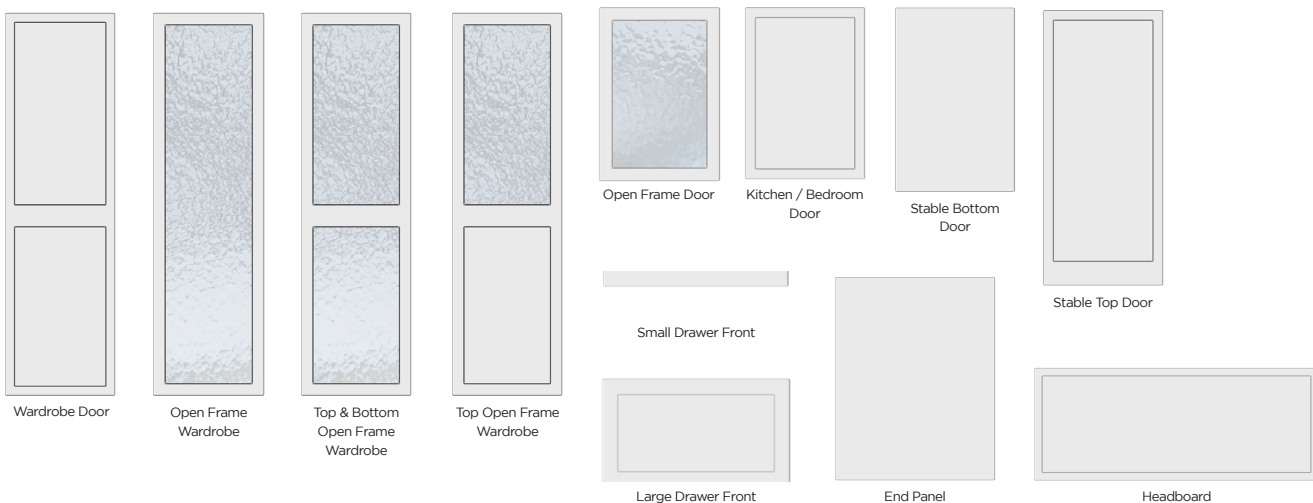

Minimum & Maximum Dimensions

Description	Min Height	Max Height	Min Width	Max Width	Notes
Drawer	100mm	355mm	140mm	1196mm	
Door	285mm	2530mm	100mm	1196mm	Plain panel when width is less than 150mm



S Standard Door Style

Belize Door Specification

All drawer fronts horizontal grain	✓
Offset panel doors	✗
Triple porthole doors	✗
Matching panels	✓
Angled & truncated doors	✗
Special sizes	✓
Matching kitchen accessories	✓
Matching bedroom accessories	✓
Cornice, pelmet & plinth	✓

Style Variations

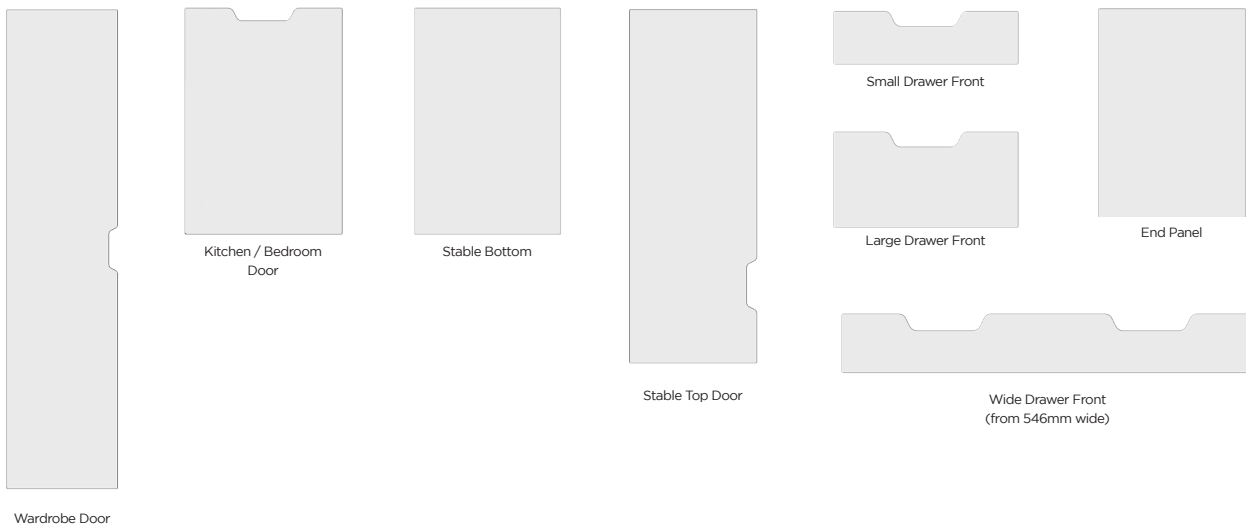

Wardrobe Door

Kitchen / Bedroom Door

Stable Bottom

Stable Top Door

Small Drawer Front

Large Drawer Front

End Panel

Wide Drawer Front
(from 546mm wide)

Minimum & Maximum Dimensions

Description	Min Height	Max Height	Min Width	Max Width	Notes
Drawer, Single Handle	100mm	355mm	270mm	1196mm	
Drawer, Dual Handle	100mm	355mm	546mm	1196mm	
Door	285mm	1700mm	270mm	1196mm	



S Standard Door Style

Benwick Door Specification

All drawer fronts horizontal grain	✓
Offset panel doors	x
Triple porthole doors	x
Matching panels	✓
Angled & truncated doors	✓
Special sizes	✓
Matching kitchen accessories	✓
Matching bedroom accessories	✓
Cornice, pelmet & plinth	✓

Style Variations

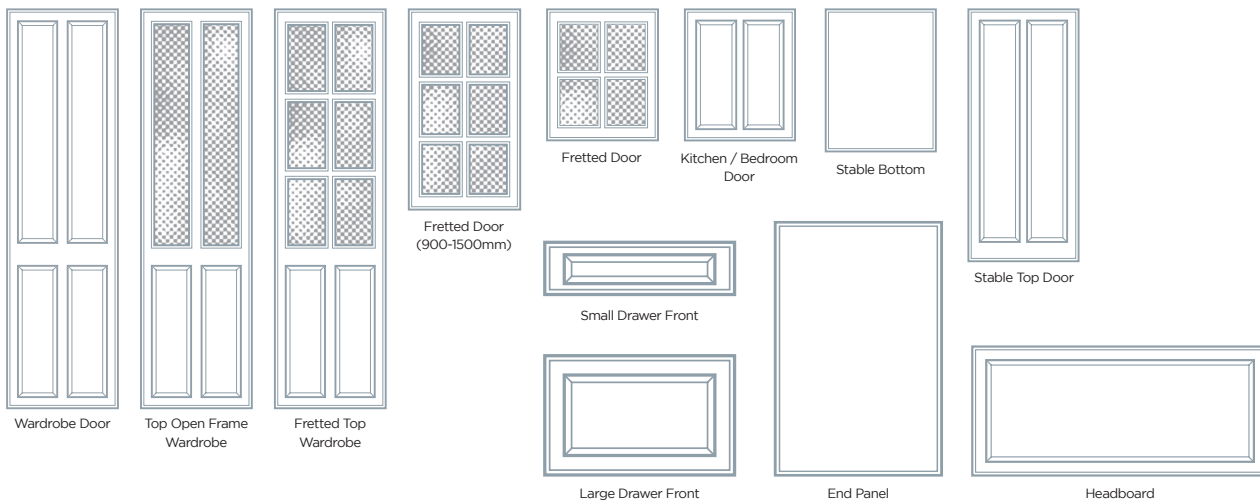

Minimum & Maximum Dimensions

Description	Min Height	Max Height	Min Width	Max Width	Notes
Drawer	100mm	355mm	140mm	1196mm	Plain panel when width is less than 210mm or height is less than 140mm.
Door	285mm	2530mm	100mm	1196mm	Plain panel when width is less than 210mm. Between 210 - 349mm width will be single panel.



S Standard Door Style

Boston Door Specification

All drawer fronts horizontal grain	✓
Offset panel doors	✗
Triple porthole doors	✗
Matching panels	✓
Angled & truncated doors	✓
Special sizes	✓
Matching kitchen accessories	✓
Matching bedroom accessories	✓
Cornice, pelmet & plinth	✓

Style Variations

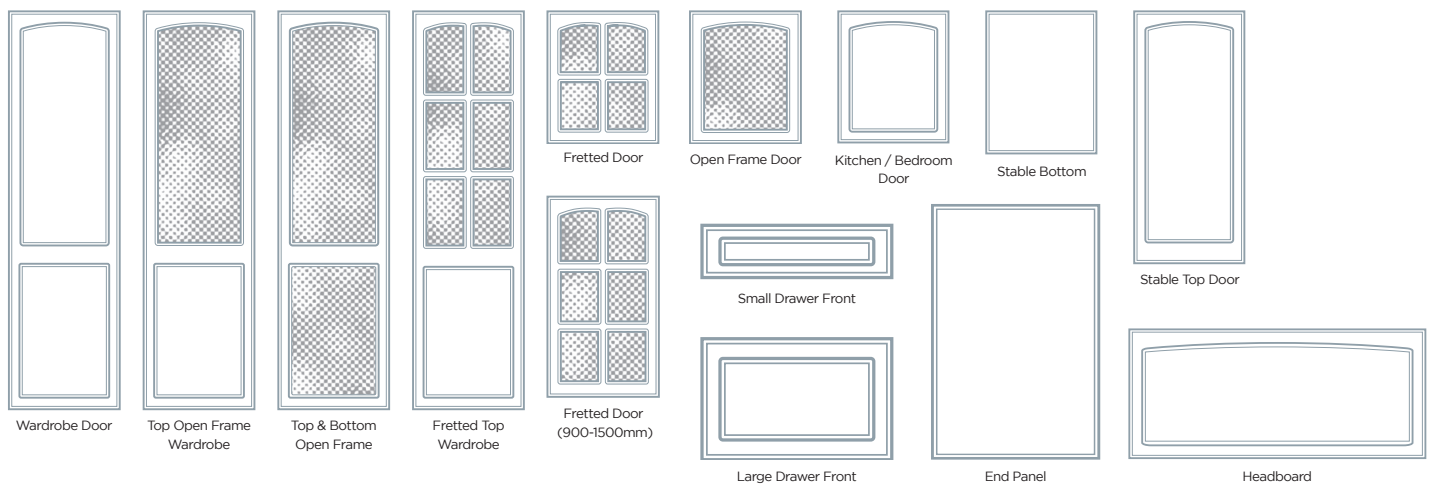

Minimum & Maximum Dimensions

Description	Min Height	Max Height	Min Width	Max Width	Notes
Drawer	100mm	355mm	140mm	1196mm	
Door	285mm	2530mm	100mm	1196mm	Plain panel when width is less than 185mm



S Standard Door Style

Brecon Door Specification

All drawer fronts horizontal grain	✓
Offset panel doors	x
Triple porthole doors	✓
Matching panels	✓
Angled & truncated doors	✓
Special sizes	✓
Matching kitchen accessories	✓
Matching bedroom accessories	✓
Cornice, pelmet & plinth	✓

Style Variations

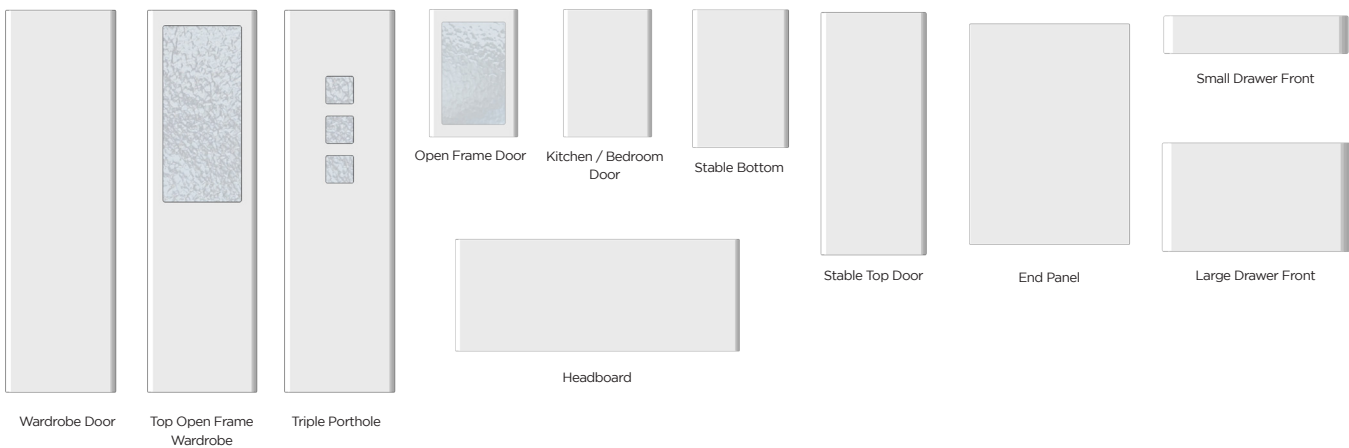

NOTES ON DRILLING

Extra care required when drilling these doors for hinges due to the doors edge thickness.
HPP cannot accept any responsibility if the door is drilled too deep

Minimum & Maximum Dimensions

Description	Min Height	Max Height	Min Width	Max Width	Notes
Drawer	100mm	355mm	140mm	1196mm	
Door	285mm	2530mm	100mm	1196mm	



P Premium Door Style

Bridgewater Door Specification

All drawer fronts horizontal grain	✓
Offset panel doors	x
Triple porthole doors	x
Matching panels	✓
Angled & truncated doors	✓
Special sizes	✓
Matching kitchen accessories	✓
Matching bedroom accessories	✓
Cornice, pelmet & plinth	✓

Style Variations

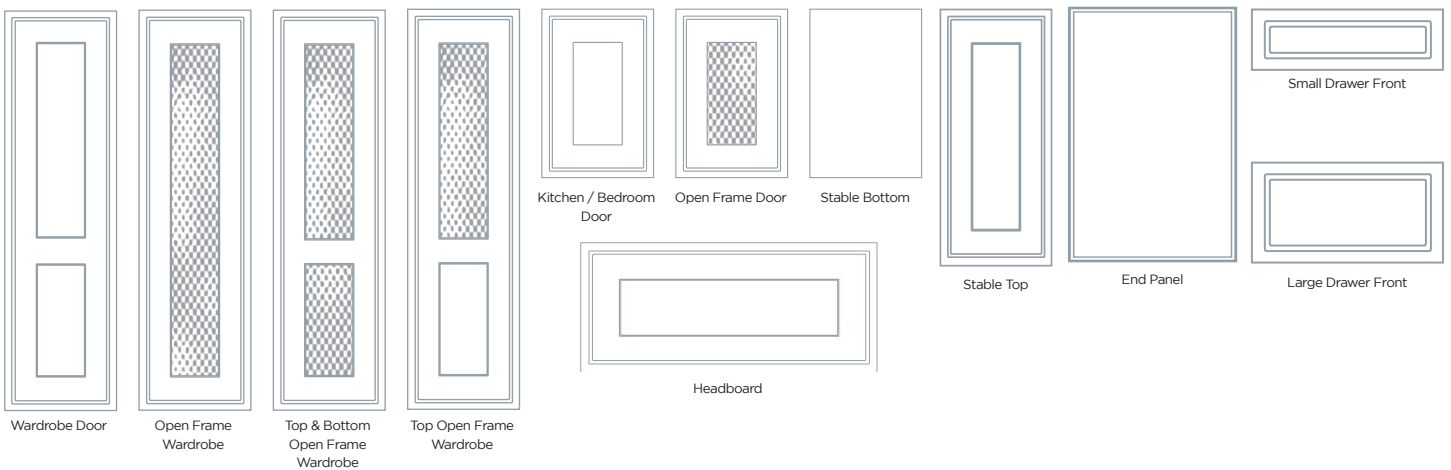

Minimum & Maximum Dimensions

Description	Min Height	Max Height	Min Width	Max Width	Notes
Drawer	100mm	355mm	140mm	1196mm	
Door	285mm	2530mm	100mm	1196mm	Plain panel when width is less than 241mm



P Premium Door Style

Brockworth Door Specification

All drawer fronts horizontal grain	✓
Offset panel doors	✗
Triple porthole doors	✗
Matching panels	✓
Angled & truncated doors	✓
Special sizes	✓
Matching kitchen accessories	✓
Matching bedroom accessories	✓
Cornice, pelmet & plinth	✓

Style Variations

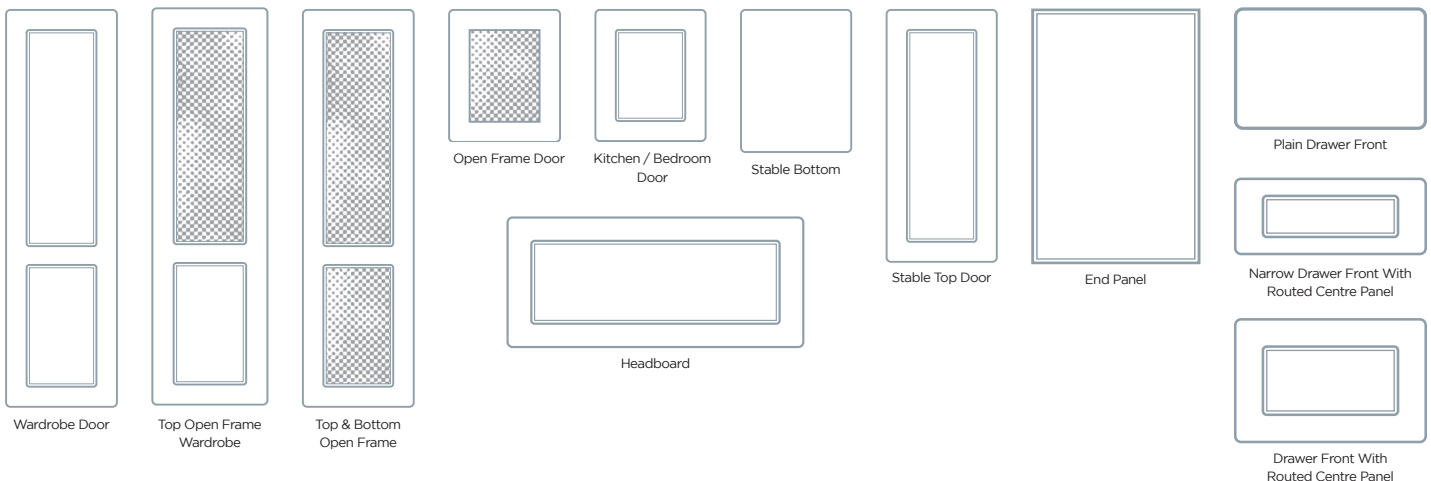

PLAIN OR ROUTED DRAWER FRONTS

If you would like a routed centre panel in your drawers, please specify **“Drawer With Centre Panel”** or **“Narrow Drawer With Centre Panel”** when ordering or choose the appropriate option when ordering online.

Minimum & Maximum Dimensions

Description	Min Height	Max Height	Min Width	Max Width	Notes
Drawer With Centre Panel	241mm	355mm	270mm	1196mm	
Narrow Drawer With Centre Panel	140mm	355mm	270mm	1196mm	Narrow top and bottom stiles (40mm)
Drawer No Centre Panel	100mm	355mm	140mm	1196mm	
Door	285mm	2530mm	100mm	1196mm	Plain panel when width is less than 270mm



S Standard Door Style

Camden Door Specification

All drawer fronts horizontal grain	✓
Offset panel doors	✓
Triple porthole doors	✗
Matching panels	✓
Angled & truncated doors	✓
Special sizes	✓
Matching kitchen accessories	✓
Matching bedroom accessories	✓
Cornice, pelmet & plinth	✓

Style Variations

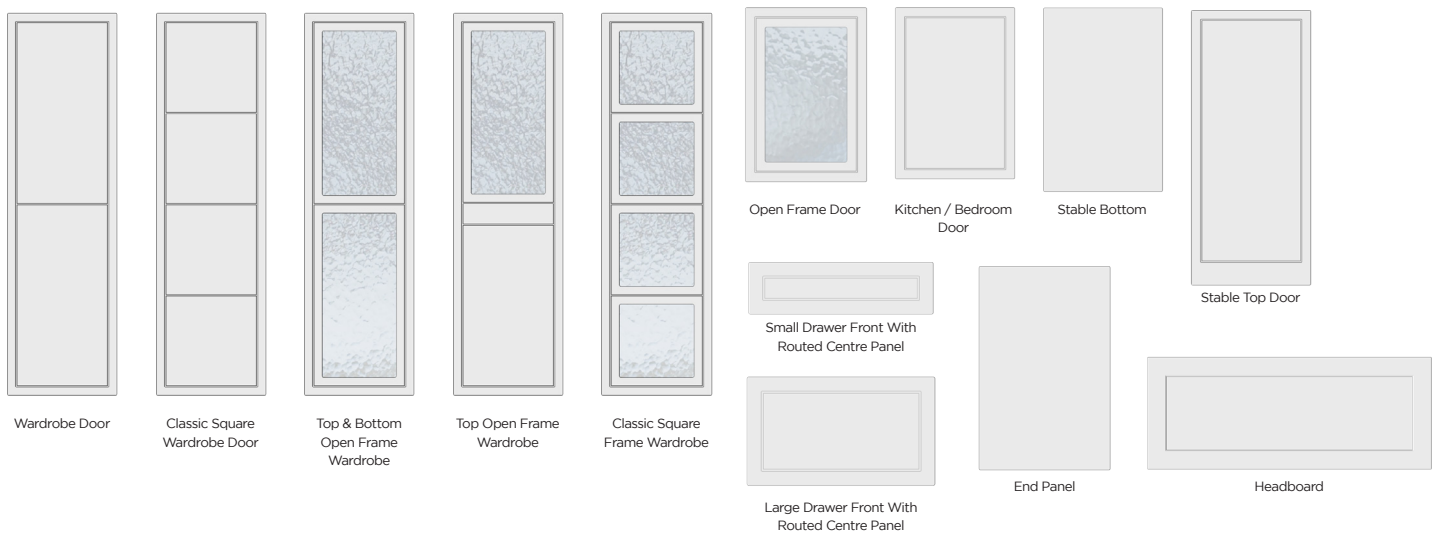

Minimum & Maximum Dimensions

Description	Min Height	Max Height	Min Width	Max Width	Notes
Drawer With Centre Panel	140mm	355mm	140mm	1196mm	
Drawer No Centre Panel	100mm	139mm	140mm	1196mm	
Door	285mm	2530mm	100mm	1196mm	Plain panel when width is less than 140mm

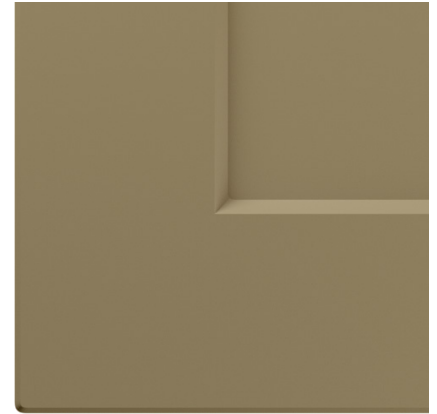

P Premium Door Style

Caraway Door Specification

All drawer fronts horizontal grain	✓
Offset panel doors	x
Triple porthole doors	x
Matching panels	✓
Angled & truncated doors	✓
Special sizes	✓
Matching kitchen accessories	✓
Matching bedroom accessories	✓
Cornice, pelmet & plinth	✓

Style Variations

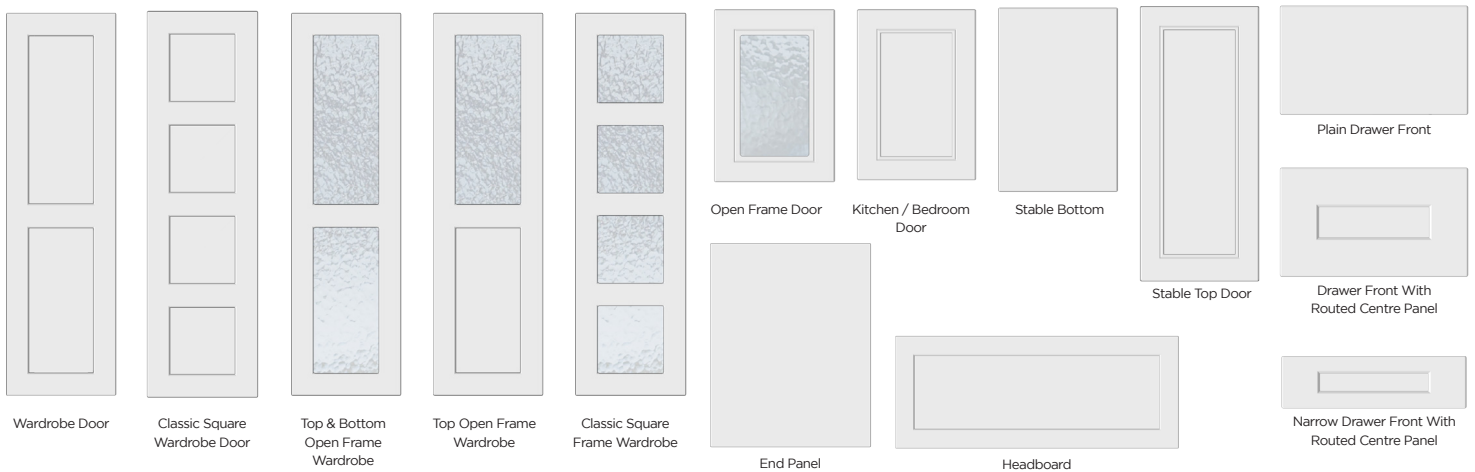

PLAIN OR ROUTED DRAWER FRONTS

If you would like a routed centre panel in your drawers, please specify **“Drawer With Centre Panel”** or **“Narrow Drawer With Centre Panel”** when ordering or choose the appropriate option when ordering online.

Minimum & Maximum Dimensions

Description	Min Height	Max Height	Min Width	Max Width	Notes
Drawer With Centre Panel	241mm	355mm	241mm	1196mm	
Narrow Drawer With Centre Panel	122mm	355mm	241mm	1196mm	Narrow top and bottom stiles (40mm)
Drawer No Centre Panel	100mm	355mm	140mm	1196mm	
Door	285mm	2530mm	100mm	1196mm	Plain panel when width is less than 241mm



S Standard Door Style

Chardonnay Door Specification

All drawer fronts horizontal grain	✓
Offset panel doors	✓
Triple porthole doors	✓
Matching panels	✓
Angled & truncated doors	✓
Special sizes	✓
Matching kitchen accessories	✓
Matching bedroom accessories	✓
Cornice, pelmet & plinth	✓

Style Variations

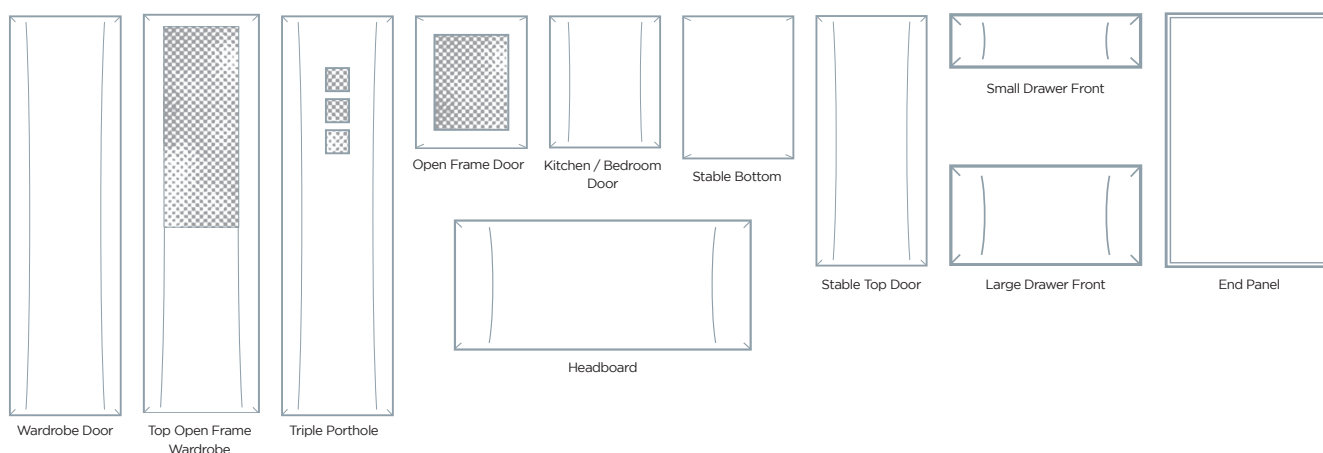

Minimum & Maximum Dimensions

Description	Min Height	Max Height	Min Width	Max Width	Notes
Drawer	100mm	355mm	140mm	1196mm	Plain panel when width is less than 250mm or height is less than 140mm.
Door	285mm	2530mm	100mm	1196mm	Plain panel when width is less than 250mm

NOTES ON DRILLING

Extra care required when drilling these doors for hinges due to the doors edge thickness.
HPP cannot accept any responsibility if the door is drilled too deep

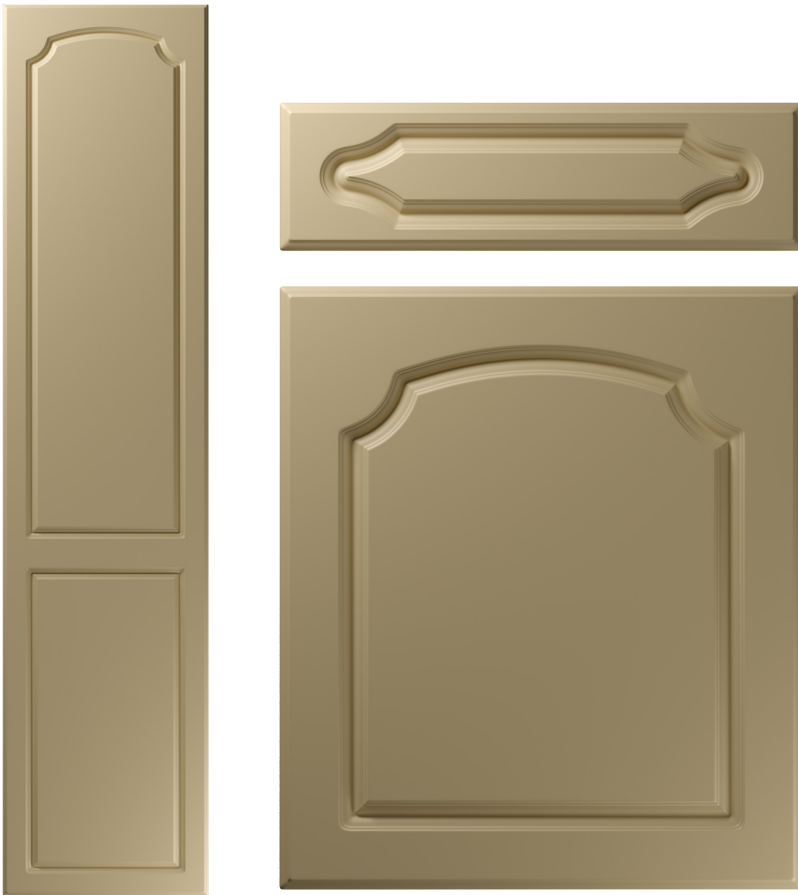

S Standard Door Style

Chedburgh Door Specification

All drawer fronts horizontal grain	✓
Offset panel doors	✗
Triple porthole doors	✗
Matching panels	✓
Angled & truncated doors	✓
Special sizes	✓
Matching kitchen accessories	✓
Matching bedroom accessories	✓
Cornice, pelmet & plinth	✓

Style Variations

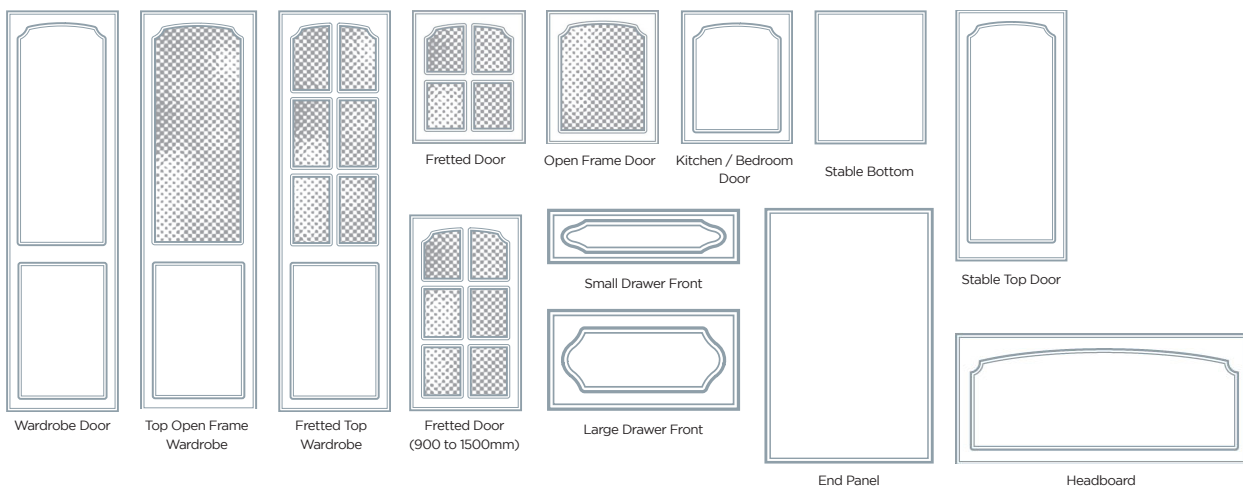

Minimum & Maximum Dimensions

Description	Min Height	Max Height	Min Width	Max Width	Notes
Drawer	100mm	355mm	140mm	1196mm	Plain panel when height is less than 140mm.
Door	285mm	2530mm	100mm	1196mm	Plain panel when width is less than 250mm



P Premium Door Style

Coniston Door Specification

All drawer fronts horizontal grain	✓
Offset panel doors	✗
Triple porthole doors	✗
Matching panels	✓
Angled & truncated doors	✓
Special sizes	✓
Matching kitchen accessories	✓
Matching bedroom accessories	✓
Cornice, pelmet & plinth	✓

Style Variations



PLAIN OR ROUTED DRAWER FRONTS

If you would like a routed centre panel in your drawers, please specify **"Drawer With Centre Panel"** when ordering or choose the **"Drawer With Centre Panel"** option when ordering online.

Minimum & Maximum Dimensions

Description	Min Height	Max Height	Min Width	Max Width	Notes
Drawer With Centre Detail	285mm	355mm	285mm	1196mm	
Drawer No Centre Detail	100mm	355mm	140mm	1196mm	
Door	241mm	2530mm	100mm	1196mm	Plain panel when height or width is less than 285mm

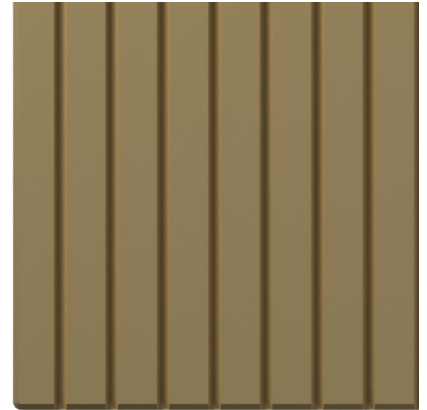
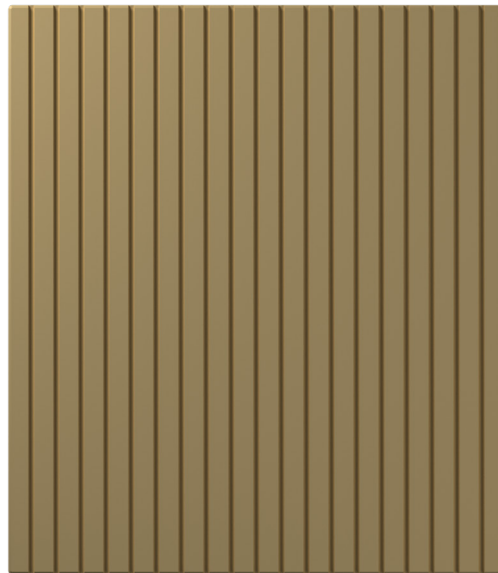
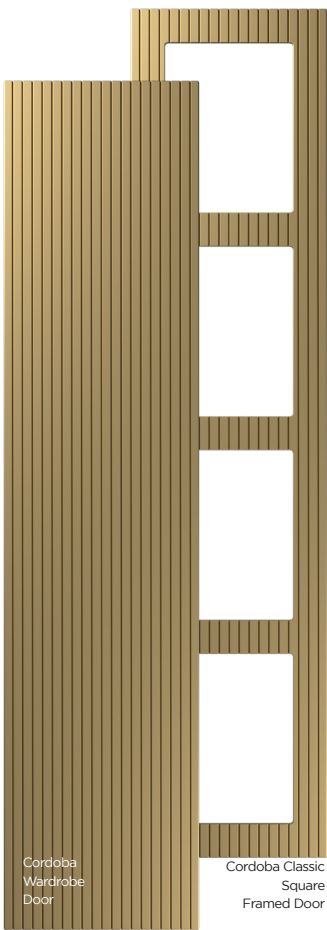

S Standard Door Style

Cordoba Door Specification

All drawer fronts horizontal grain	✓
Offset panel doors	✓
Triple porthole doors	x
Matching panels	✓
Angled & truncated doors	✓
Special sizes	✓
Matching kitchen accessories	✓
Matching bedroom accessories	✓
Cornice, pelmet & plinth	✓

Style Variations

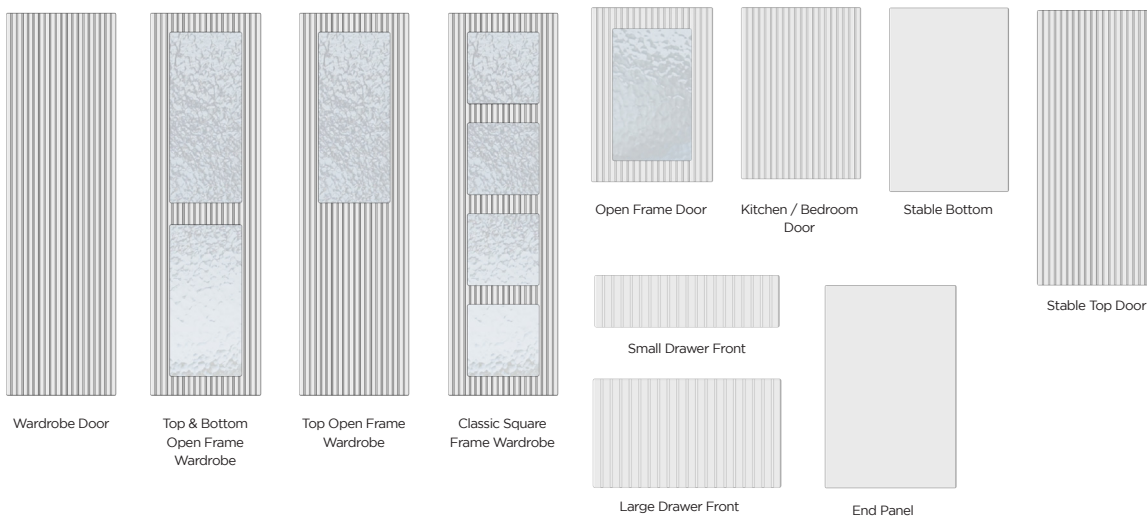

Minimum & Maximum Dimensions

Description	Min Height	Max Height	Min Width	Max Width	Notes
Drawer	100mm	355mm	140mm	1196mm	
Door	285mm	2530mm	100mm	1196mm	



S Standard Door Style

Cottage Door Specification

All drawer fronts horizontal grain	✓
Offset panel doors	✗
Triple porthole doors	✗
Matching panels	✓
Angled & truncated doors	✓
Special sizes	✓
Matching kitchen accessories	✓
Matching bedroom accessories	✓
Cornice, pelmet & plinth	✓

Style Variations

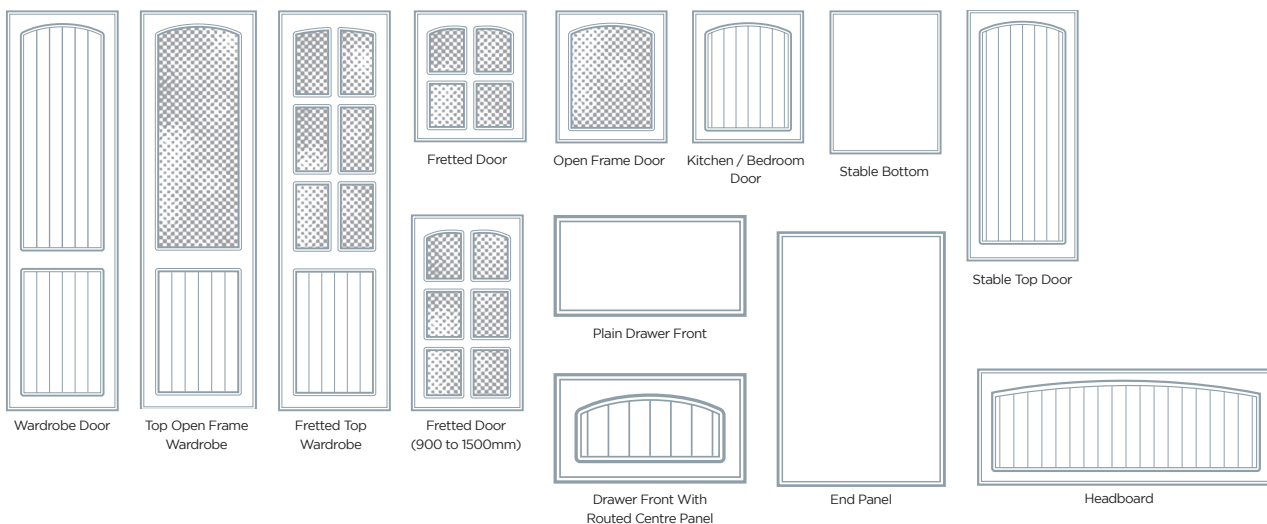

PLAIN OR ROUTED DRAWER FRONTS

If you would like a routed centre panel in your drawers, please specify **"Drawer With Centre Panel"** when ordering or choose the **"Drawer With Centre Panel"** option when ordering online.

Minimum & Maximum Dimensions

Description	Min Height	Max Height	Min Width	Max Width	Notes
Drawer With Centre Detail	241mm	355mm	140mm	1196mm	
Drawer No Centre Detail	100mm	355mm	140mm	1196mm	
Door	285mm	2530mm	100mm	1196mm	Plain panel when width is less than 250mm



S Standard Door Style

Crossland Door Specification

All drawer fronts horizontal grain	✓
Offset panel doors	✓
Triple porthole doors	✓
Matching panels	✓
Angled & truncated doors	✓
Special sizes	✓
Matching kitchen accessories	✓
Matching bedroom accessories	✓
Cornice, pelmet & plinth	✓

Style Variations

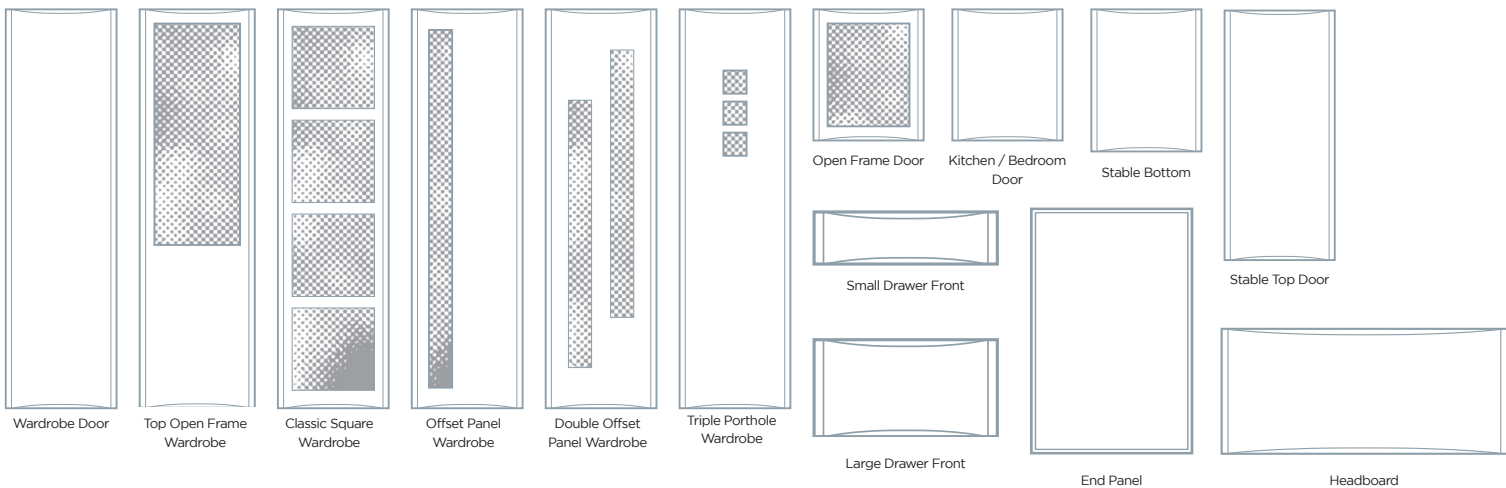

NOTES ON DRILLING

Extra care required when drilling these doors for hinges due to the doors edge thickness.
HPP cannot accept any responsibility if the door is drilled too deep

Minimum & Maximum Dimensions

Description	Min Height	Max Height	Min Width	Max Width
Drawer	100mm	355mm	140mm	1196mm
Door	285mm	2530mm	100mm	1196mm

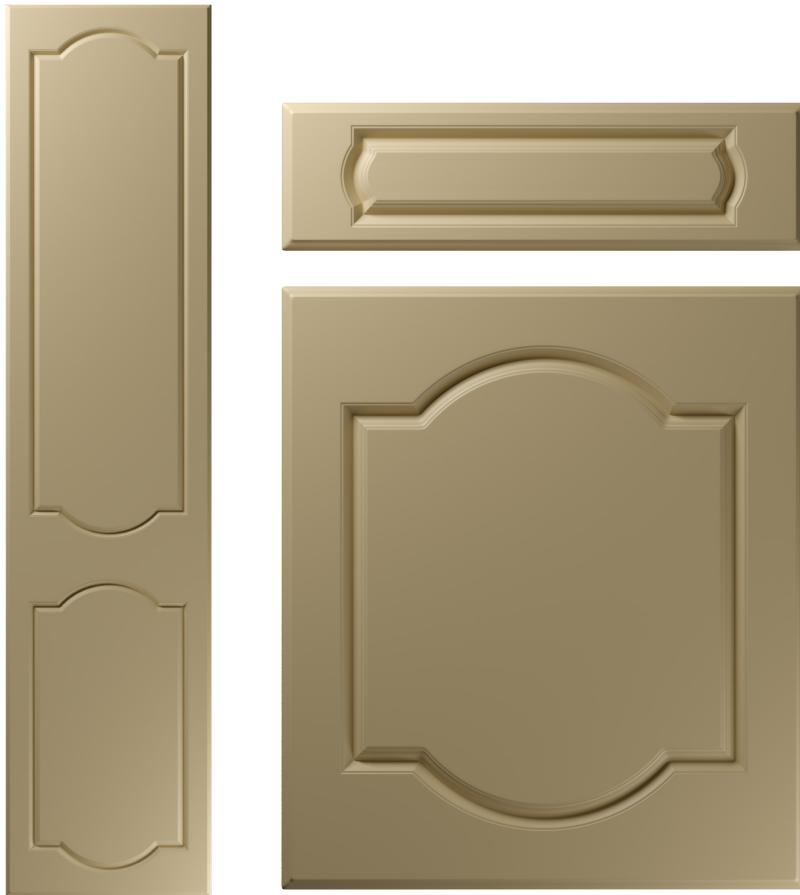

S Standard Door Style

Denham Door Specification

All drawer fronts horizontal grain	✓
Offset panel doors	✗
Triple porthole doors	✗
Matching panels	✓
Angled & truncated doors	✓
Special sizes	✓
Matching kitchen accessories	✓
Matching bedroom accessories	✓
Cornice, pelmet & plinth	✓

Style Variations

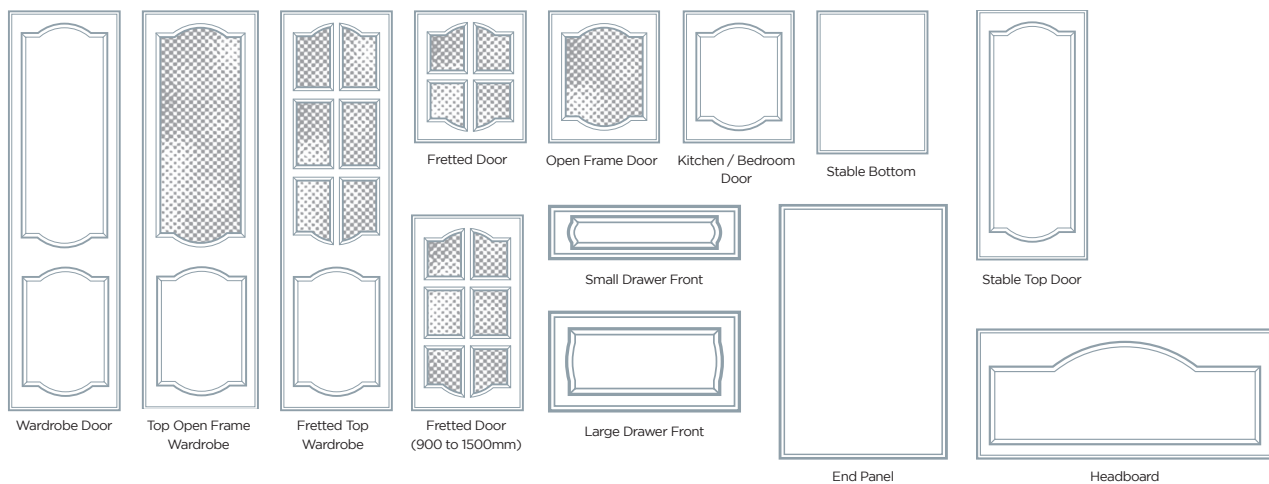

Minimum & Maximum Dimensions

Description	Min Height	Max Height	Min Width	Max Width	Notes
Drawer	100mm	355mm	140mm	1196mm	Plain panel when height is less than 140mm.
Door	285mm	2530mm	100mm	1196mm	Plain panel when width is less than 250mm



P Premium Door Style

Denver Door Specification

All drawer fronts horizontal grain	✓
Offset panel doors	x
Triple porthole doors	x
Matching panels	✓
Angled & truncated doors	✓
Special sizes	✓
Matching kitchen accessories	✓
Matching bedroom accessories	✓
Cornice, pelmet & plinth	✓

Style Variations

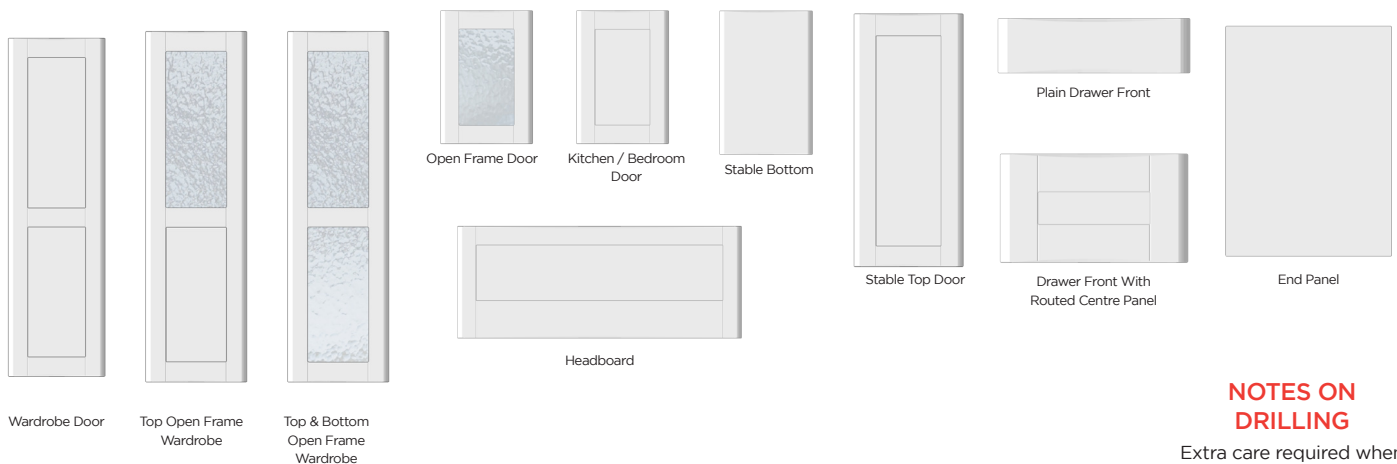

Wardrobe Door

Top Open Frame Wardrobe

Top & Bottom Open Frame Wardrobe

Open Frame Door

Kitchen / Bedroom Door

Stable Bottom

Stable Top Door

Plain Drawer Front

Drawer Front With Routed Centre Panel

End Panel

Headboard

NOTES ON DRILLING

Extra care required when drilling these doors for hinges due to the doors edge thickness. HPP cannot accept any responsibility if the door is drilled too deep

PLAIN OR ROUTED DRAWER FRONTS

If you would like a routed centre panel in your drawers, please specify **"Drawer With Centre Panel"** when ordering or choose the **"Drawer With Centre Panel"** option when ordering online.

Minimum & Maximum Dimensions

Description	Min Height	Max Height	Min Width	Max Width	Notes
Drawer With Centre Panel	241mm	355mm	140mm	1196mm	
Drawer No Centre Panel	100mm	355mm	140mm	1196mm	
Door	285mm	2530mm	100mm	1196mm	Plain panel when width is less than 241mm



S Standard Door Style

Esquire Door Specification

All drawer fronts horizontal grain	✓
Offset panel doors	x
Triple porthole doors	✓
Matching panels	✓
Angled & truncated doors	✓
Special sizes	✓
Matching kitchen accessories	✓
Matching bedroom accessories	✓
Cornice, pelmet & plinth	✓

Style Variations

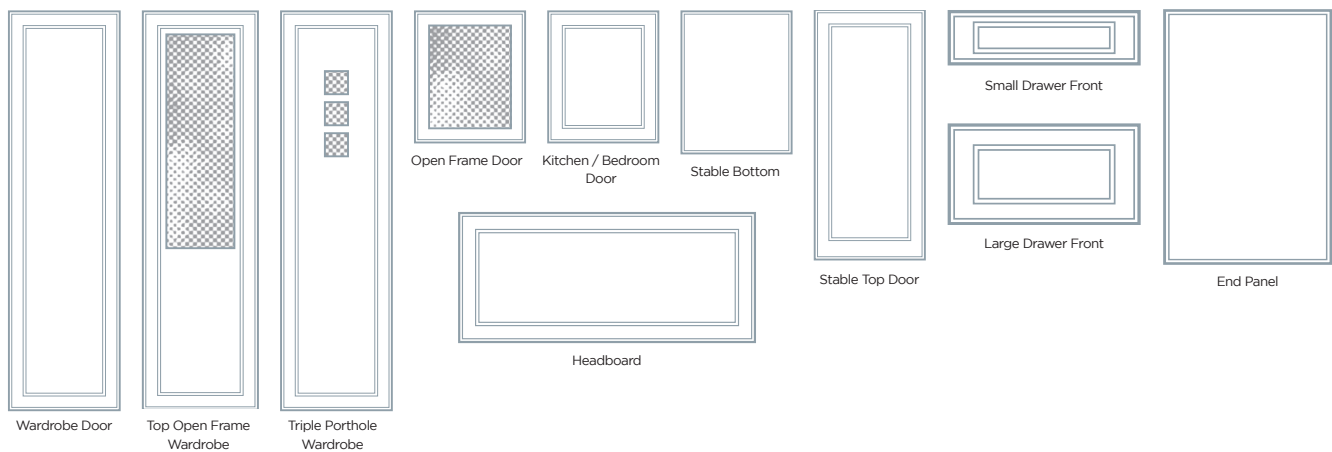

Minimum & Maximum Dimensions

Description	Min Height	Max Height	Min Width	Max Width	Notes
Drawer	100mm	355mm	140mm	1196mm	Plain panel when width is less than 180mm or height is less than 140mm.
Door	285mm	2530mm	100mm	1196mm	Plain panel when width is less than 180mm



S Standard Door Style

Fenwick Door Specification

All drawer fronts horizontal grain	✓
Offset panel doors	x
Triple porthole doors	x
Matching panels	✓
Angled & truncated doors	✓
Special sizes	✓
Matching kitchen accessories	✓
Matching bedroom accessories	✓
Cornice, pelmet & plinth	✓

Style Variations

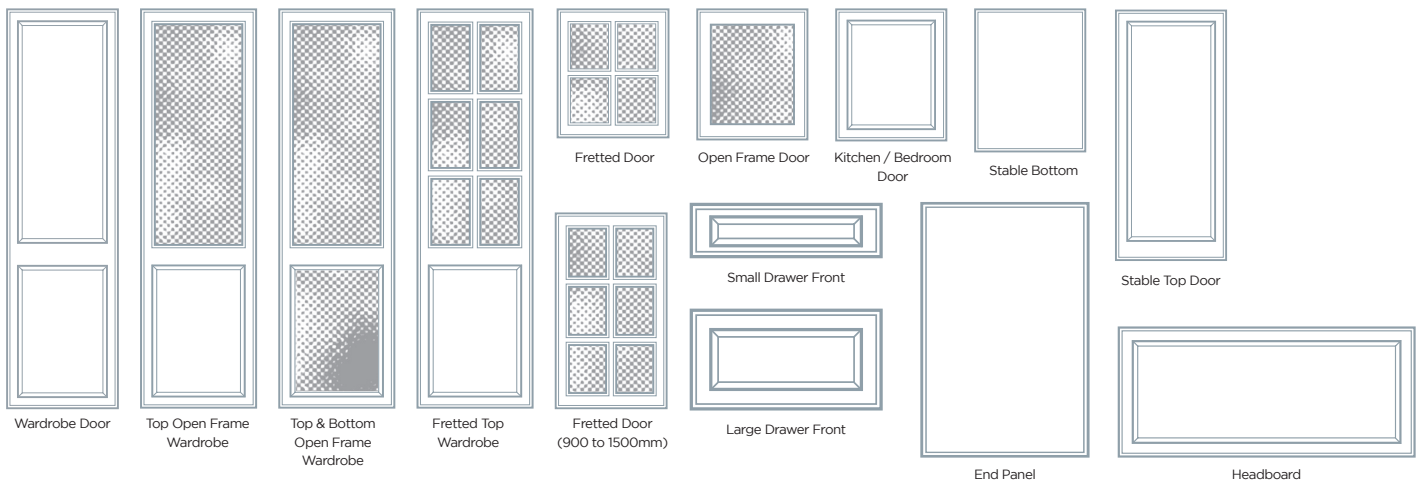

Minimum & Maximum Dimensions

Description	Min Height	Max Height	Min Width	Max Width	Notes
Drawer	100mm	355mm	140mm	1196mm	Plain panel when width is less than 210mm or height is less than 140mm.
Door	285mm	2530mm	100mm	1196mm	Plain panel when width is less than 210mm

BEDROOM EXCLUSIVE STYLE

Florence Door Specification

All drawer fronts horizontal grain	✓
Offset panel doors	✓
Triple porthole doors	x
Matching panels	✓
Angled & truncated doors	✓
Special sizes	✓
Matching kitchen accessories	✓
Matching bedroom accessories	✓
Cornice, pelmet & plinth	✓



Style Variations

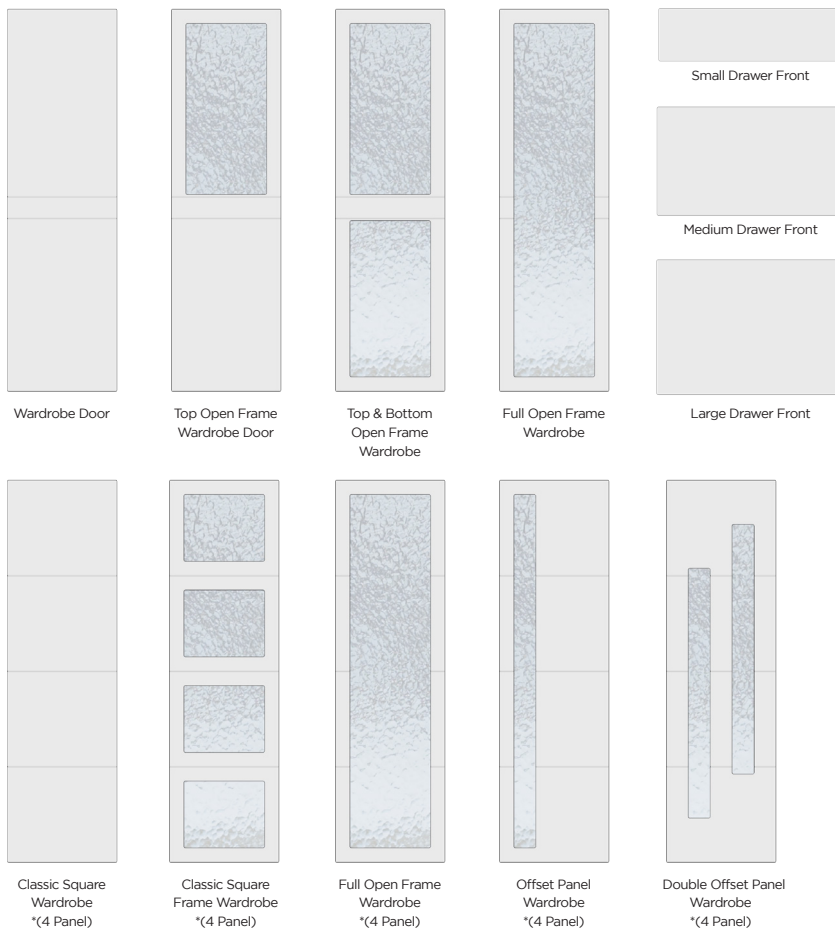

*Style variations are available in 2 panel to 6 panel options

Minimum & Maximum Dimensions

Description	Min Height	Max Height	Min Width	Max Width
Drawer	100mm	355mm	140mm	1196mm
Door	285mm	2530mm	100mm	1196mm



S Standard Door Style



S Standard Door Style

Genoa Door Specification

All drawer fronts horizontal grain	✓
Offset panel doors	✓
Triple porthole doors	✓
Matching panels	✓
Angled & truncated doors	✓
Special sizes	✓
Matching kitchen accessories	✓
Matching bedroom accessories	✓
Cornice, pelmet & plinth	✓

Style Variations

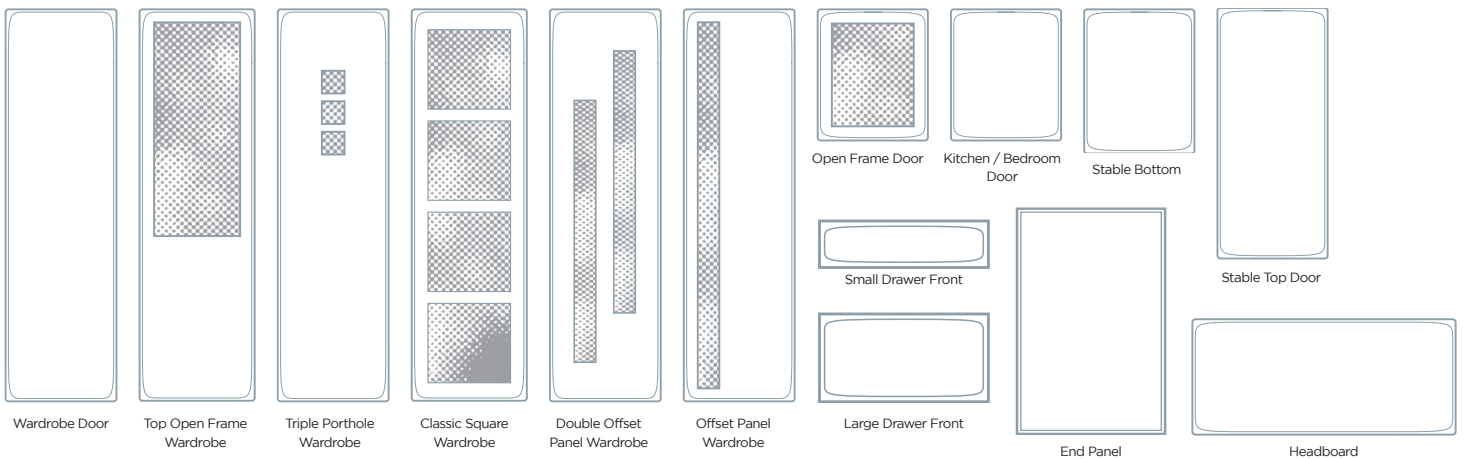

Minimum & Maximum Dimensions

Description	Min Height	Max Height	Min Width	Max Width	Notes
Drawer	100mm	355mm	140mm	1196mm	
Door	285mm	2530mm	100mm	1196mm	

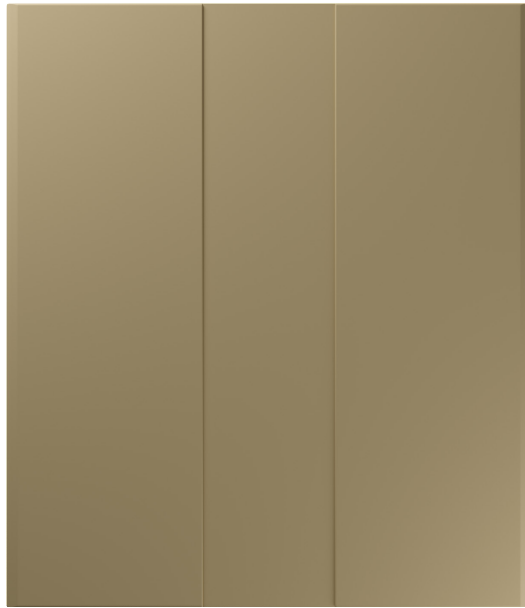

S Standard Door Style

Grove Door Specification

All drawer fronts horizontal grain	✓
Offset panel doors	✗
Triple porthole doors	✗
Matching panels	✓
Angled & truncated doors	✓
Special sizes	✓
Matching kitchen accessories	✓
Matching bedroom accessories	✓
Cornice, pelmet & plinth	✓
Route groove 126mm wide	

Style Variations

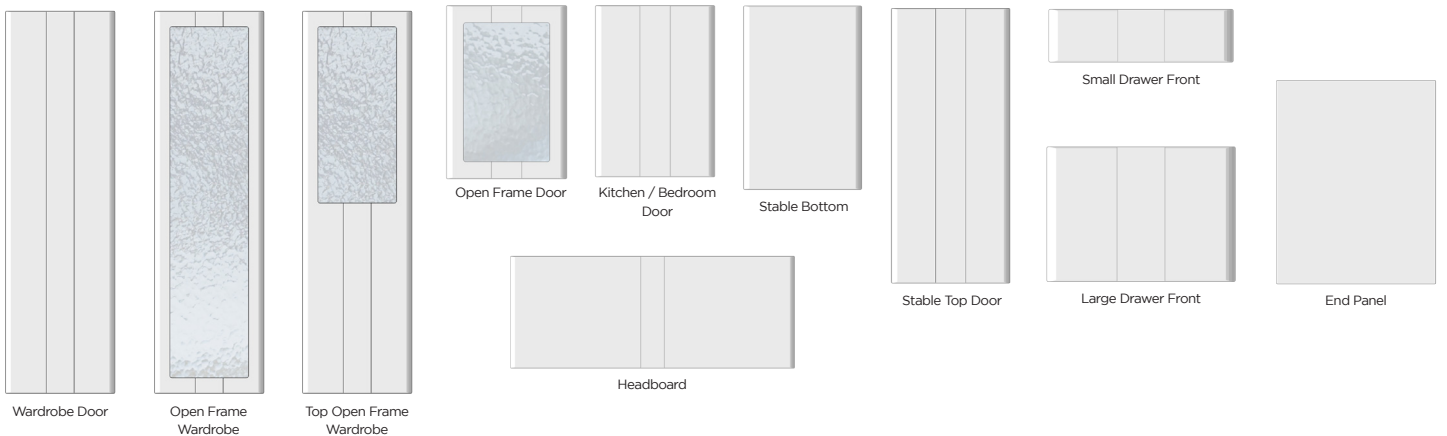

Wardrobe Door

Open Frame Wardrobe

Top Open Frame Wardrobe

Open Frame Door

Kitchen / Bedroom Door

Stable Bottom

Stable Top Door

Small Drawer Front

Large Drawer Front

End Panel

Headboard

NOTES ON DRILLING

Extra care required when drilling these doors for hinges due to the doors edge thickness.

HPP cannot accept any responsibility if the door is drilled too deep

Minimum & Maximum Dimensions

Description	Min Height	Max Height	Min Width	Max Width	Notes
Drawer	100mm	355mm	140mm	1196mm	
Door	285mm	2530mm	100mm	1196mm	Plain panel when width is less than 250mm



S Standard Door Style

Halstead Door Specification

All drawer fronts horizontal grain	✓
Offset panel doors	✗
Triple porthole doors	✗
Matching panels	✓
Angled & truncated doors	✓
Special sizes	✓
Matching kitchen accessories	✓
Matching bedroom accessories	✓
Cornice, pelmet & plinth	✓

Style Variations

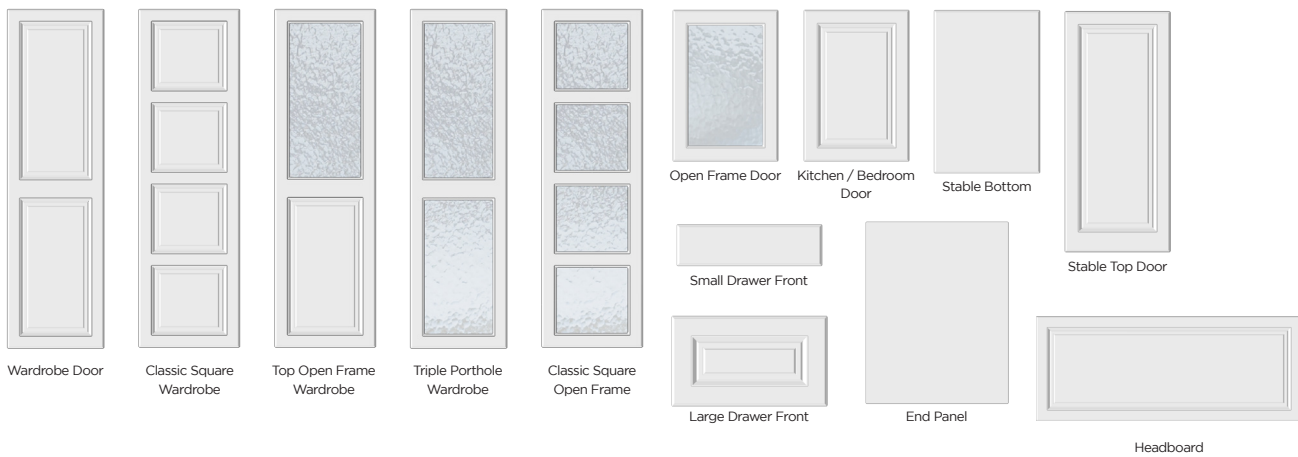

Minimum & Maximum Dimensions

Description	Min Height	Max Height	Min Width	Max Width	Notes
Drawer With Centre Panel	232mm	355mm	232mm	1196mm	
Drawer No Centre Panel	100mm	355mm	140mm	1196mm	
Door	285mm	2530mm	100mm	1196mm	Plain panel when width is less than 232mm

BEDROOM EXCLUSIVE STYLE

Havana Door Specification

All drawer fronts horizontal grain	✓
Offset panel doors	✓
Triple porthole doors	x
Matching panels	✓
Angled & truncated doors	✓
Special sizes	✓
Matching kitchen accessories	✓
Matching bedroom accessories	✓
Cornice, pelmet & plinth	✓



Style Variations

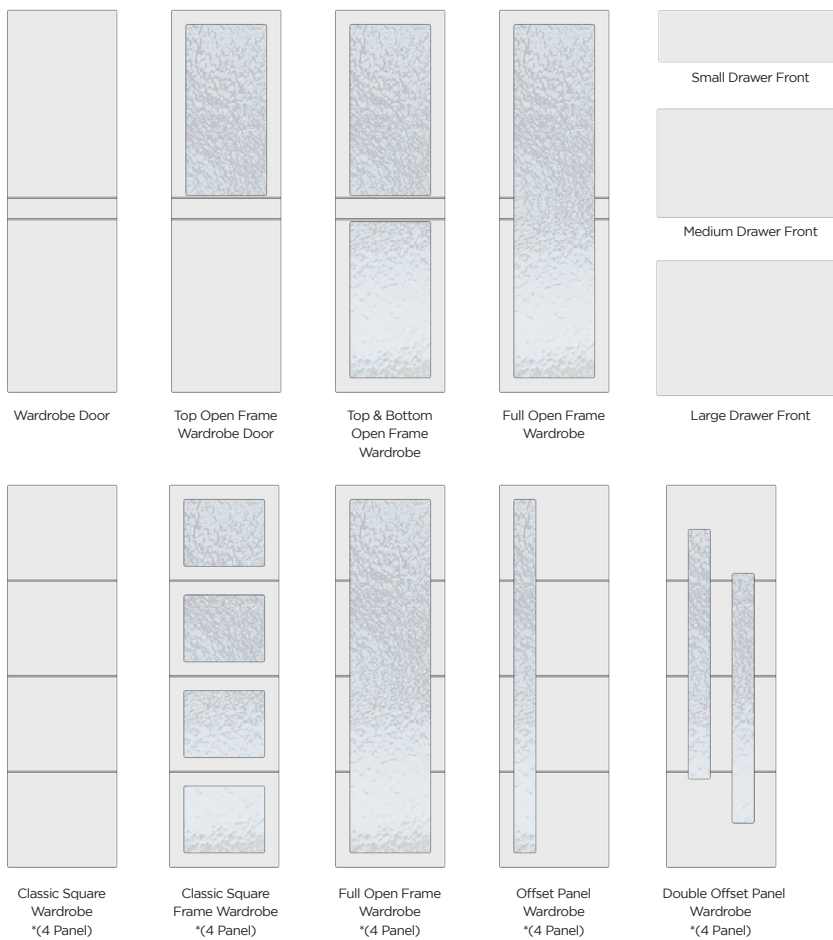

*Style variations are available in 2 panel to 6 panel options

Minimum & Maximum Dimensions

Description	Min Height	Max Height	Min Width	Max Width
Drawer	100mm	355mm	140mm	1196mm
Door	285mm	2530mm	100mm	1196mm



S Standard Door Style

Henlow - (Raised Centre Panel)

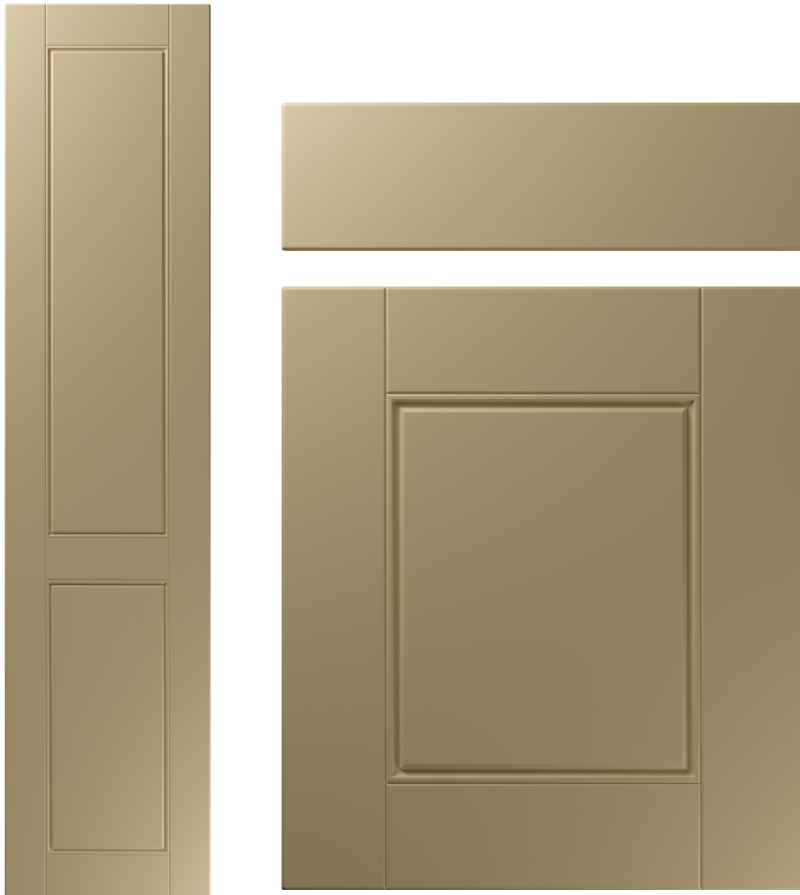

P Premium Door Style

Henlow Door Specification

All drawer fronts horizontal grain	✓
Offset panel doors	✗
Triple porthole doors	✗
Matching panels	✓
Angled & truncated doors	✓
Special sizes	✓
Matching kitchen accessories	✓
Matching bedroom accessories	✓
Cornice, pelmet & plinth	✓

Style Variations

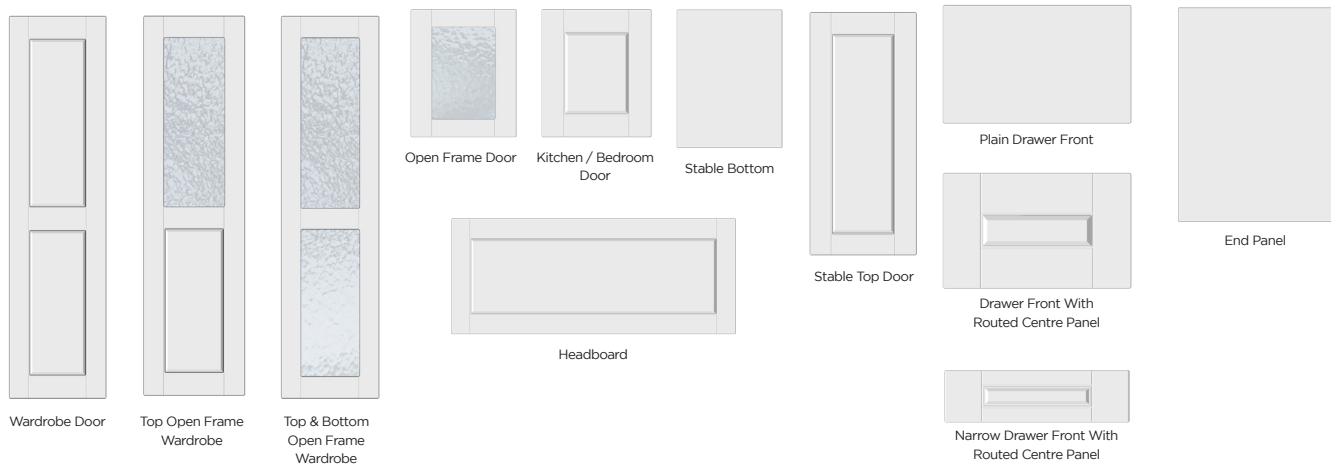

PLAIN OR ROUTED DRAWER FRONTS

If you would like a routed centre panel in your drawers, please specify **“Drawer With Centre Panel”** or **“Narrow Drawer With Centre Panel”** when ordering or choose the appropriate option when ordering online.

Minimum & Maximum Dimensions

Description	Min Height	Max Height	Min Width	Max Width	Notes
Drawer With Centre Panel	241mm	355mm	241mm	1196mm	
Narrow Drawer With Centre Panel	140mm	355mm	241mm	1196mm	Narrow top and bottom stiles (40mm)
Drawer No Centre Panel	100mm	355mm	140mm	1196mm	
Door	285mm	2530mm	100mm	1196mm	Plain panel when width is less than 241mm



P Premium Door Style

Hudson Door Specification

All drawer fronts horizontal grain	✓
Offset panel doors	x
Triple porthole doors	x
Matching panels	✓
Angled & truncated doors	✓
Special sizes	✓
Matching kitchen accessories	✓
Matching bedroom accessories	✓
Cornice, pelmet & plinth	✓

Style Variations



PLAIN OR ROUTED DRAWER FRONTS

If you would like a routed centre panel in your drawers, please specify **“Drawer With Centre Panel”** or **“Narrow Drawer With Centre Panel”** when ordering or choose the appropriate option when ordering online.

Minimum & Maximum Dimensions

Description	Min Height	Max Height	Min Width	Max Width	Notes
Drawer With Centre Panel	220mm	355mm	220mm	1196mm	
Narrow Drawer With Centre Panel	140mm	355mm	220mm	1196mm	Narrow top and bottom stiles (40mm)
Drawer No Centre Panel	100mm	355mm	140mm	1196mm	
Door	285mm	2530mm	100mm	1196mm	Plain panel when width is less than 220mm

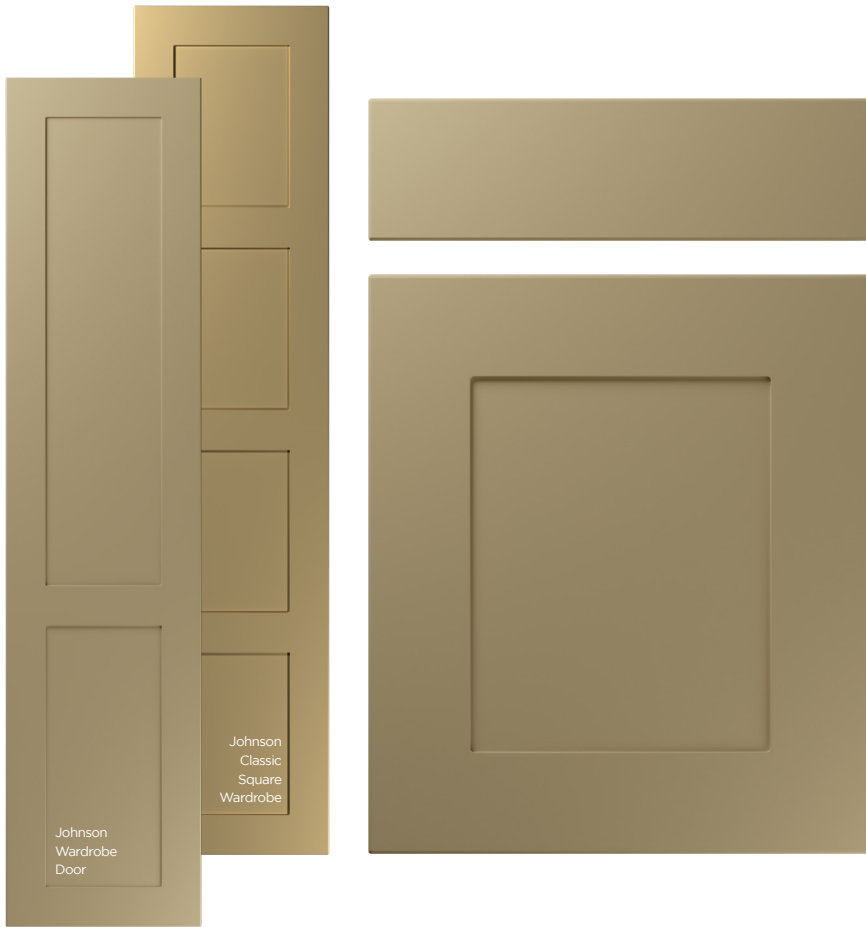

P Premium Door Style

Johnson Door Specification

All drawer fronts horizontal grain	✓
Offset panel doors	✗
Triple porthole doors	✗
Matching panels	✓
Angled & truncated doors	✓
Special sizes	✓
Matching kitchen accessories	✓
Matching bedroom accessories	✓
Cornice, pelmet & plinth	✓

Style Variations

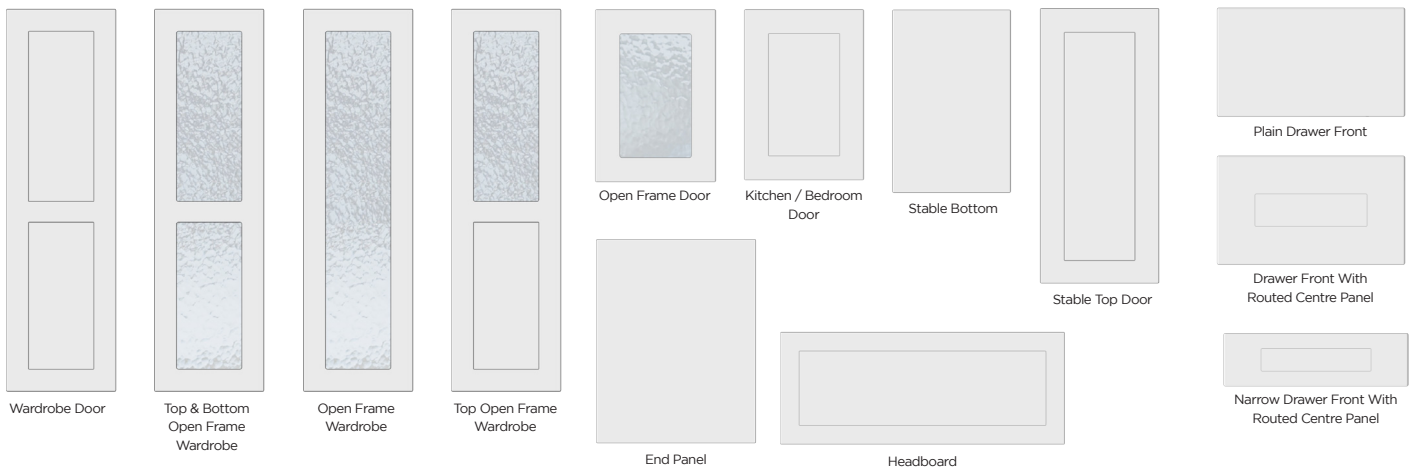

PLAIN OR ROUTED DRAWER FRONTS

If you would like a routed centre panel in your drawers, please specify **“Drawer With Centre Panel”** or **“Narrow Drawer With Centre Panel”** when ordering or choose the appropriate option when ordering online.

Minimum & Maximum Dimensions

Description	Min Height	Max Height	Min Width	Max Width	Notes
Drawer With Centre Panel	241mm	355mm	241mm	1196mm	
Narrow Drawer With Centre Panel	110mm	355mm	241mm	1196mm	Narrow top and bottom stiles (40mm)
Drawer No Centre Panel	100mm	355mm	140mm	1196mm	
Door	285mm	2530mm	100mm	1196mm	Plain panel when width is less than 241mm

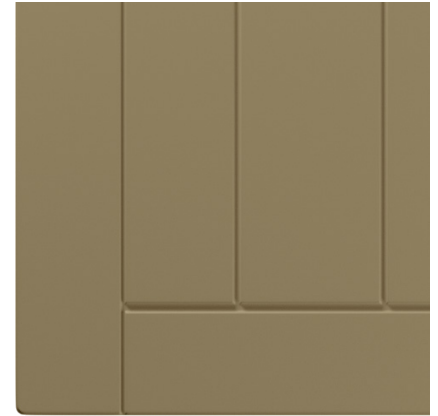
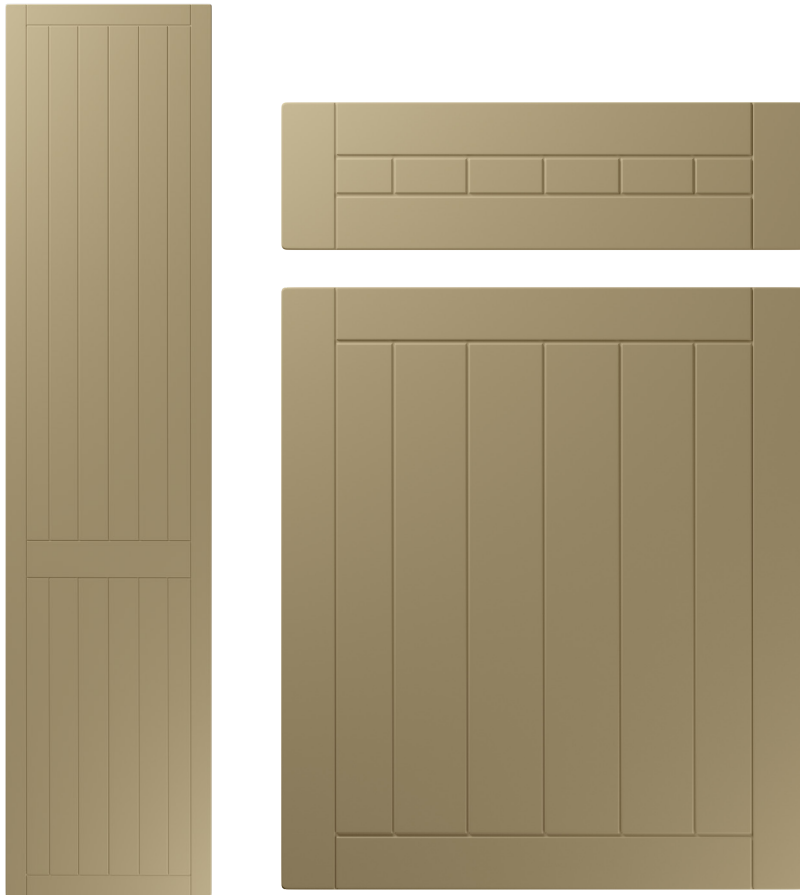

S Standard Door Style

Juliette Door Specification

All drawer fronts horizontal grain	✓
Offset panel doors	✗
Triple porthole doors	✗
Matching panels	✓
Angled & truncated doors	✓
Special sizes	✓
Matching kitchen accessories	✓
Matching bedroom accessories	✓
Cornice, pelmet & plinth	✓

Style Variations

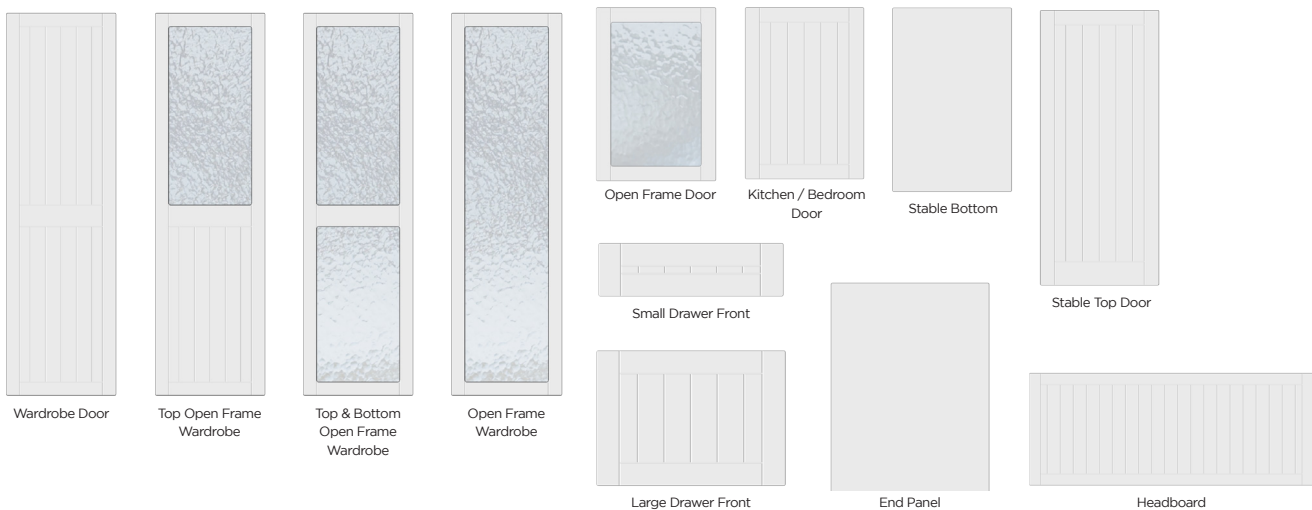

Minimum & Maximum Dimensions

Description	Min Height	Max Height	Min Width	Max Width	Notes
Drawer	100mm	355mm	140mm	1196mm	Plain panel when width is less than 190mm or height is less than 140mm.
Door	285mm	2530mm	100mm	1196mm	Plain panel when width is less than 190mm

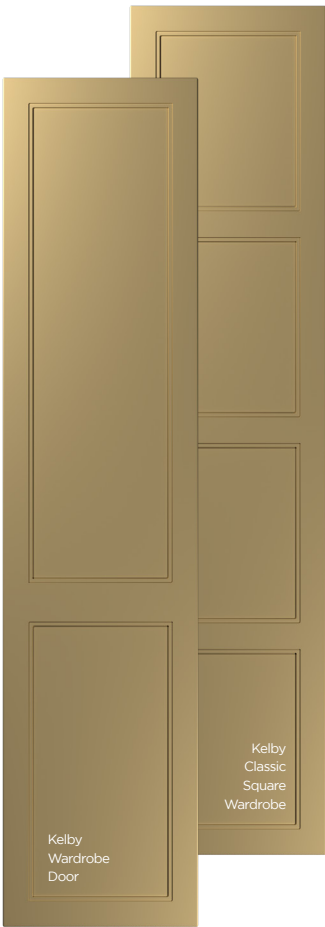

P Premium Door Style

Kelby Door Specification

All drawer fronts horizontal grain	✓
Offset panel doors	✗
Triple porthole doors	✗
Matching panels	✓
Angled & truncated doors	✓
Special sizes	✓
Matching kitchen accessories	✓
Matching bedroom accessories	✓
Cornice, pelmet & plinth	✓

Style Variations

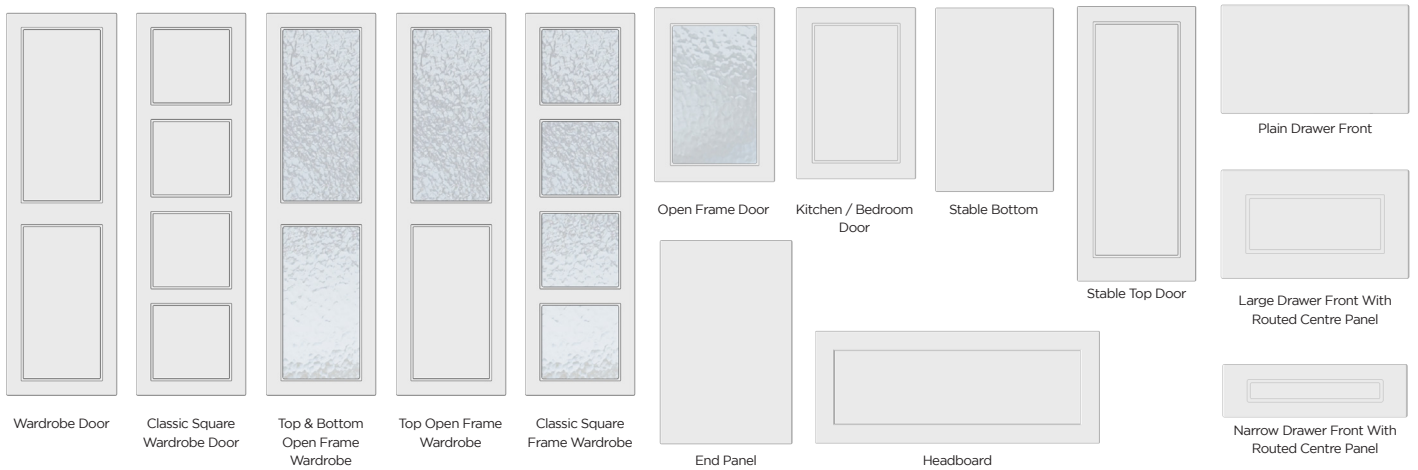

PLAIN OR ROUTED DRAWER FRONTS

If you would like a routed centre panel in your drawers, please specify **“Drawer With Centre Panel”** or **“Narrow Drawer With Centre Panel”** when ordering or choose the appropriate option when ordering online.

Minimum & Maximum Dimensions

Description	Min Height	Max Height	Min Width	Max Width	Notes
Drawer With Centre Panel	175mm	355mm	175mm	1196mm	
Narrow Drawer With Centre Panel	140mm	355mm	175mm	1196mm	Narrow top and bottom stiles (40mm)
Drawer No Centre Panel	100mm	355mm	140mm	1196mm	
Door	285mm	2530mm	100mm	1196mm	Plain panel when width is less than 175mm



- P** Premium Door Style
- W** 22mm Thickness & White Back

Kendal Door Specification

All drawer fronts horizontal grain	✓
Offset panel doors	✓
Triple porthole doors	✓
Matching panels	✓
Angled & truncated doors	✓
Special sizes	✓
Matching kitchen accessories	✓
Matching bedroom accessories	✓
Cornice, pelmet & plinth	✓

Style Variations

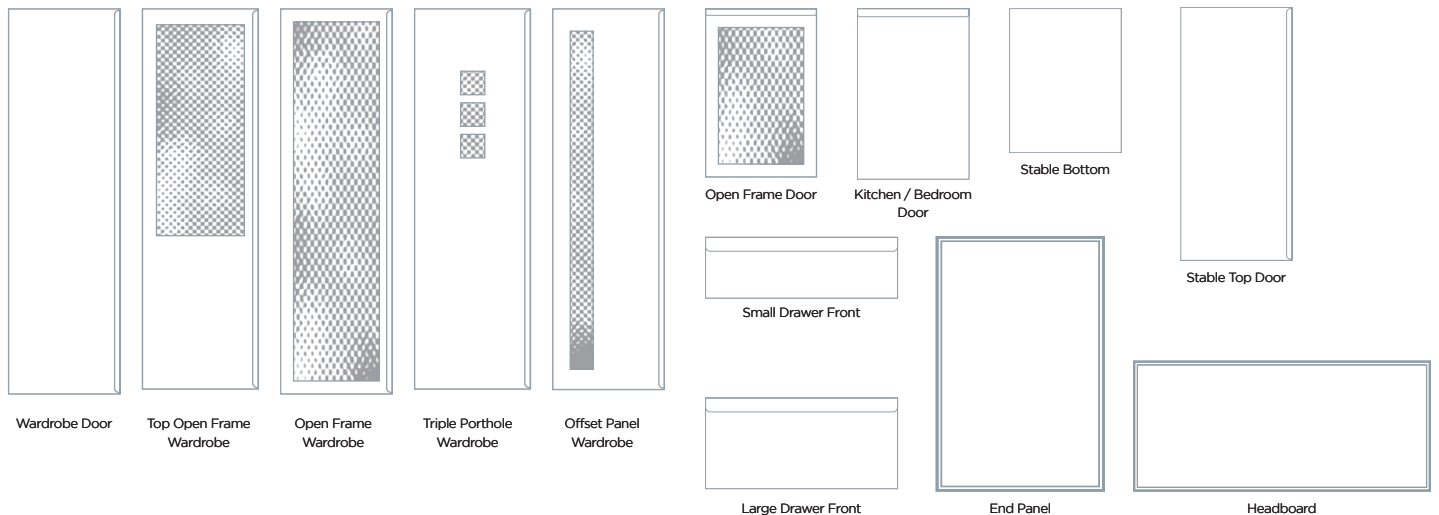

Minimum & Maximum Dimensions

Description	Min Height	Max Height	Min Width	Max Width	Notes
Drawer	100mm	355mm	140mm	1196mm	
Door	285mm	1700mm	100mm	1196mm	



P Premium Door Style

Keswick Door Specification

All drawer fronts horizontal grain	✓
Offset panel doors	x
Triple porthole doors	x
Matching panels	✓
Angled & truncated doors	✓
Special sizes	✓
Matching kitchen accessories	✓
Matching bedroom accessories	✓
Cornice, pelmet & plinth	✓

Style Variations

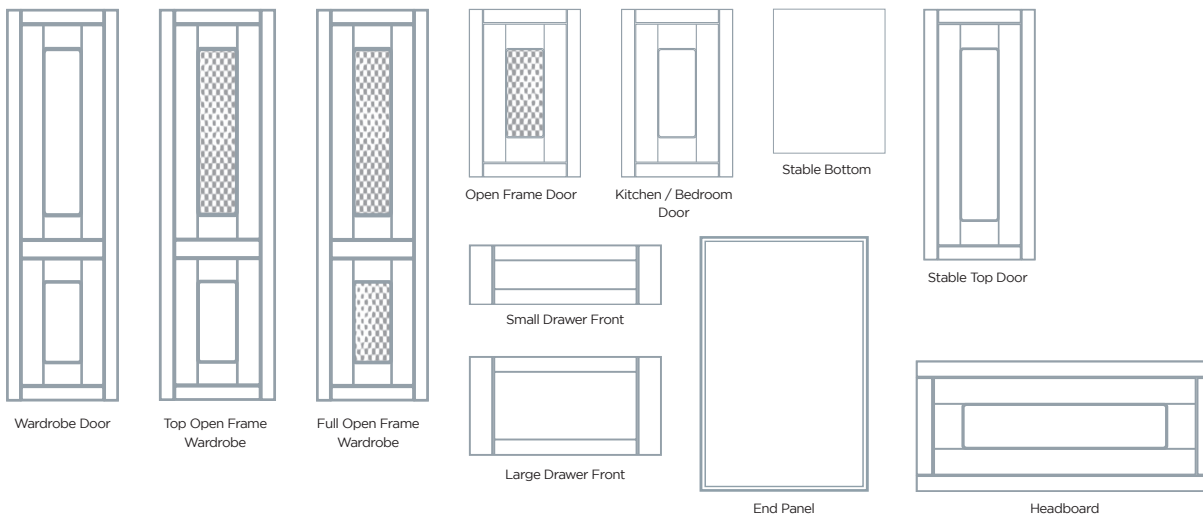

Minimum & Maximum Dimensions

Description	Min Height	Max Height	Min Width	Max Width	Notes
Drawer	100mm	355mm	140mm	1196mm	
Door	285mm	2530mm	100mm	1196mm	Plain panel when width is less than 272mm



S Standard Door Style

Linea Door Specification

All drawer fronts horizontal grain	✓
Offset panel doors	✓
Triple porthole doors	✓
Matching panels	✓
Angled & truncated doors	✓
Special sizes	✓
Matching kitchen accessories	✓
Matching bedroom accessories	✓
Cornice, pelmet & plinth	✓

Style Variations

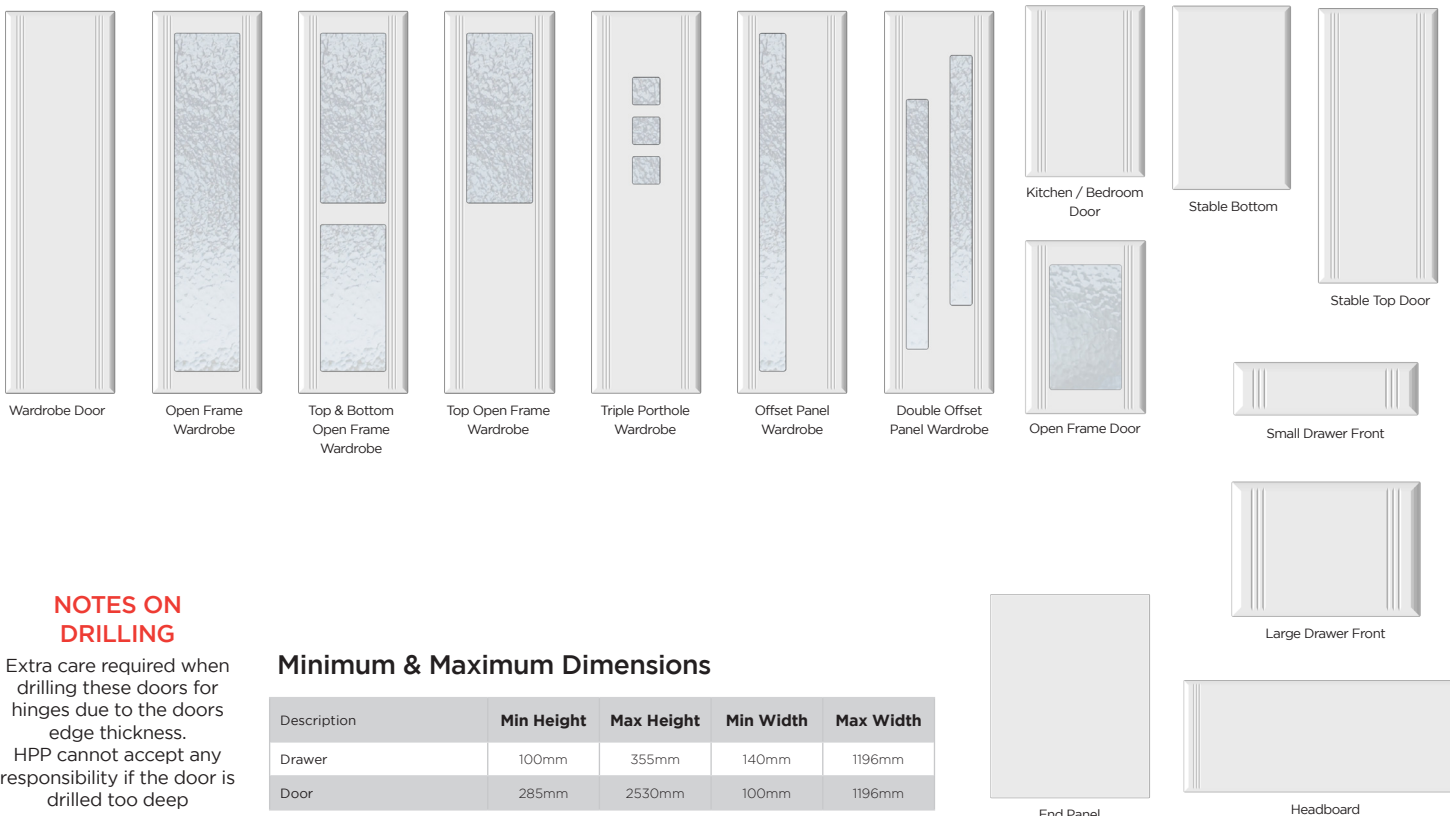

NOTES ON DRILLING

Extra care required when drilling these doors for hinges due to the doors edge thickness. HPP cannot accept any responsibility if the door is drilled too deep

Minimum & Maximum Dimensions

Description	Min Height	Max Height	Min Width	Max Width
Drawer	100mm	355mm	140mm	1196mm
Door	285mm	2530mm	100mm	1196mm



S Standard Door Style

Madrid Door Specification

All drawer fronts horizontal grain	✓
Offset panel doors	✗
Triple porthole doors	✗
Matching panels	✓
Angled & truncated doors	✓
Special sizes	✓
Matching kitchen accessories	✓
Matching bedroom accessories	✓
Cornice, pelmet & plinth	✓

Style Variations

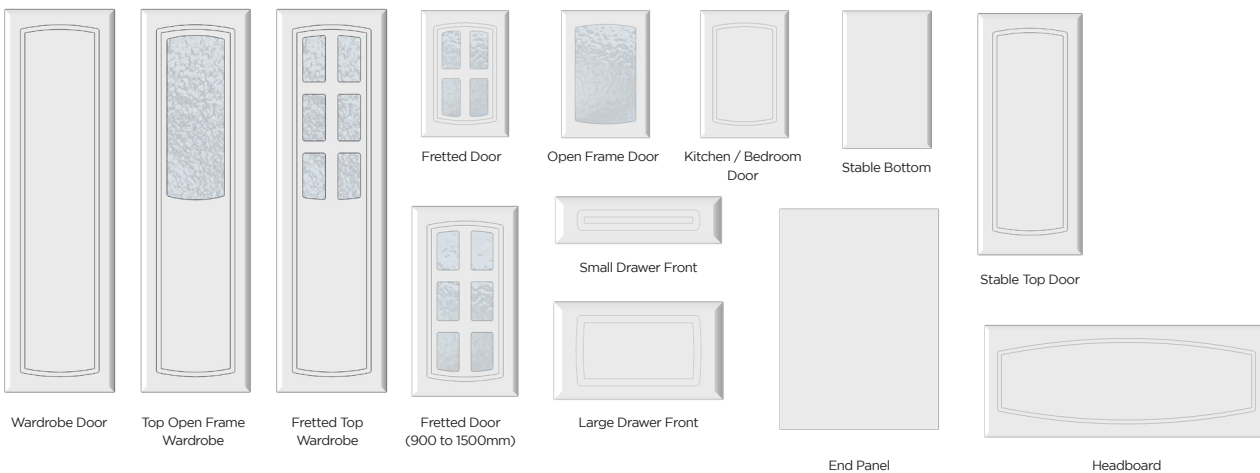

NOTES ON DRILLING

Extra care required when drilling these doors for hinges due to the doors edge thickness.
HPP cannot accept any responsibility if the door is drilled too deep

Minimum & Maximum Dimensions

Description	Min Height	Max Height	Min Width	Max Width	Notes
Drawer	100mm	355mm	140mm	1196mm	Plain panel when height is less than 140mm.
Door	285mm	2530mm	100mm	1196mm	Plain panel when width is less than 200mm



S Standard Door Style

Manhattan Door Specification

All drawer fronts horizontal grain	✓
Offset panel doors	✓
Triple porthole doors	✓
Matching panels	✓
Angled & truncated doors	✓
Special sizes	✓
Matching kitchen accessories	✓
Matching bedroom accessories	✓
Cornice, pelmet & plinth	✓

Style Variations

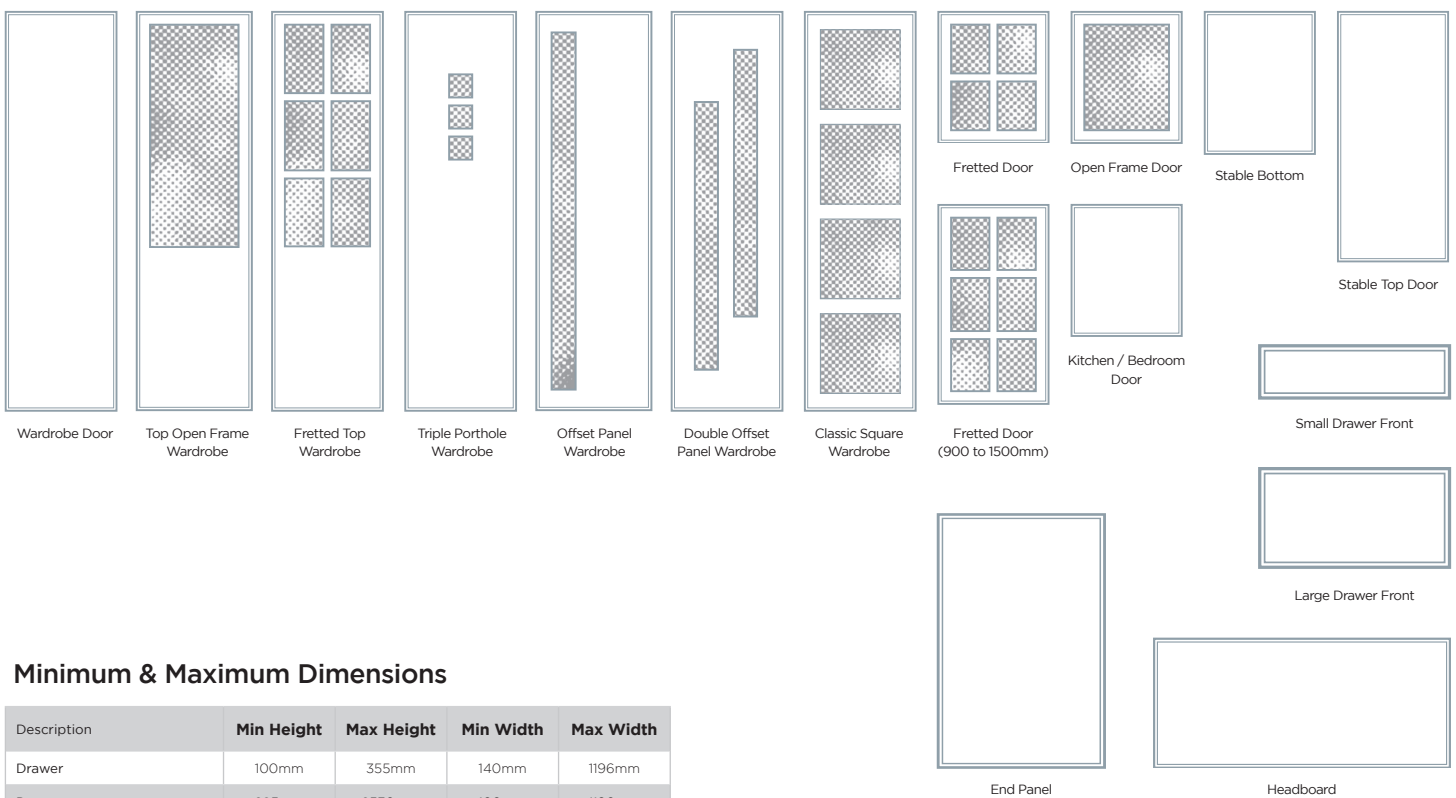

Minimum & Maximum Dimensions

Description	Min Height	Max Height	Min Width	Max Width
Drawer	100mm	355mm	140mm	1196mm
Door	285mm	2530mm	100mm	1196mm



P Premium Door Style

Mercia Door Specification

All drawer fronts horizontal grain	✓
<i>Skinny</i> style with 60mm narrow frame	✓
Offset panel doors	✗
Triple porthole doors	✗
Matching panels	✓
Angled & truncated doors	✓
Special sizes	✓
Matching kitchen accessories	✓
Matching bedroom accessories	✓
Cornice, pelmet & plinth	✓

Style Variations

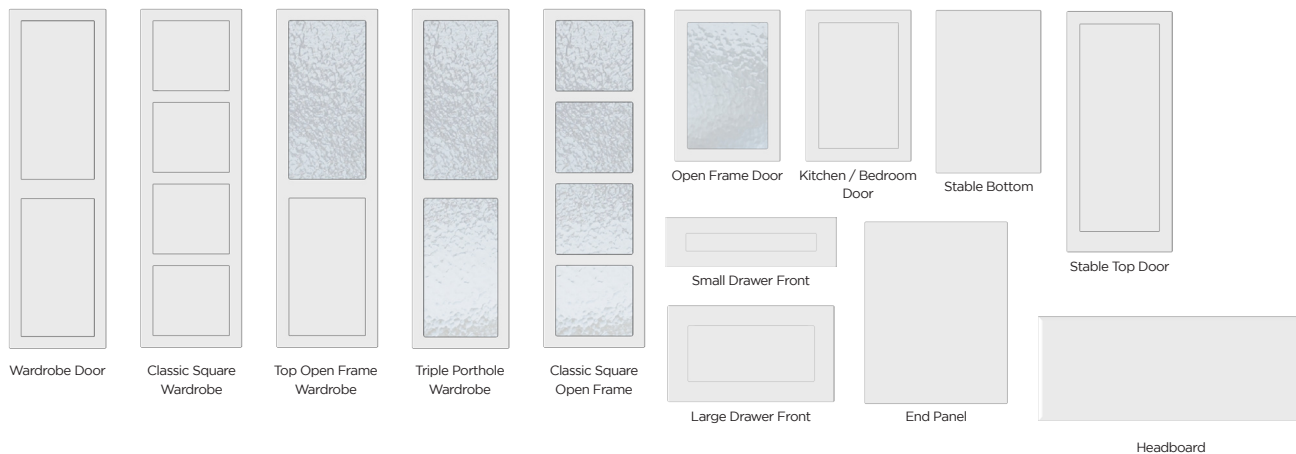

Minimum & Maximum Dimensions

Description	Min Height	Max Height	Min Width	Max Width	Notes
Drawer	100mm	355mm	140mm	1196mm	When height is between 140mm to 169mm, frame height is 45mm instead of 60mm. Plain panel when height is less than 140mm or width is less than 147mm.
Door	285mm	2530mm	100mm	1196mm	Plain panel when width is less than 147mm



S Standard Door Style

Mersey Door Specification

All drawer fronts horizontal grain	✓
Offset panel doors	✓
Triple porthole doors	✓
Matching panels	✓
Angled & truncated doors	✓
Special sizes	✓
Matching kitchen accessories	✓
Matching bedroom accessories	✓
Cornice, pelmet & plinth	✓

Style Variations

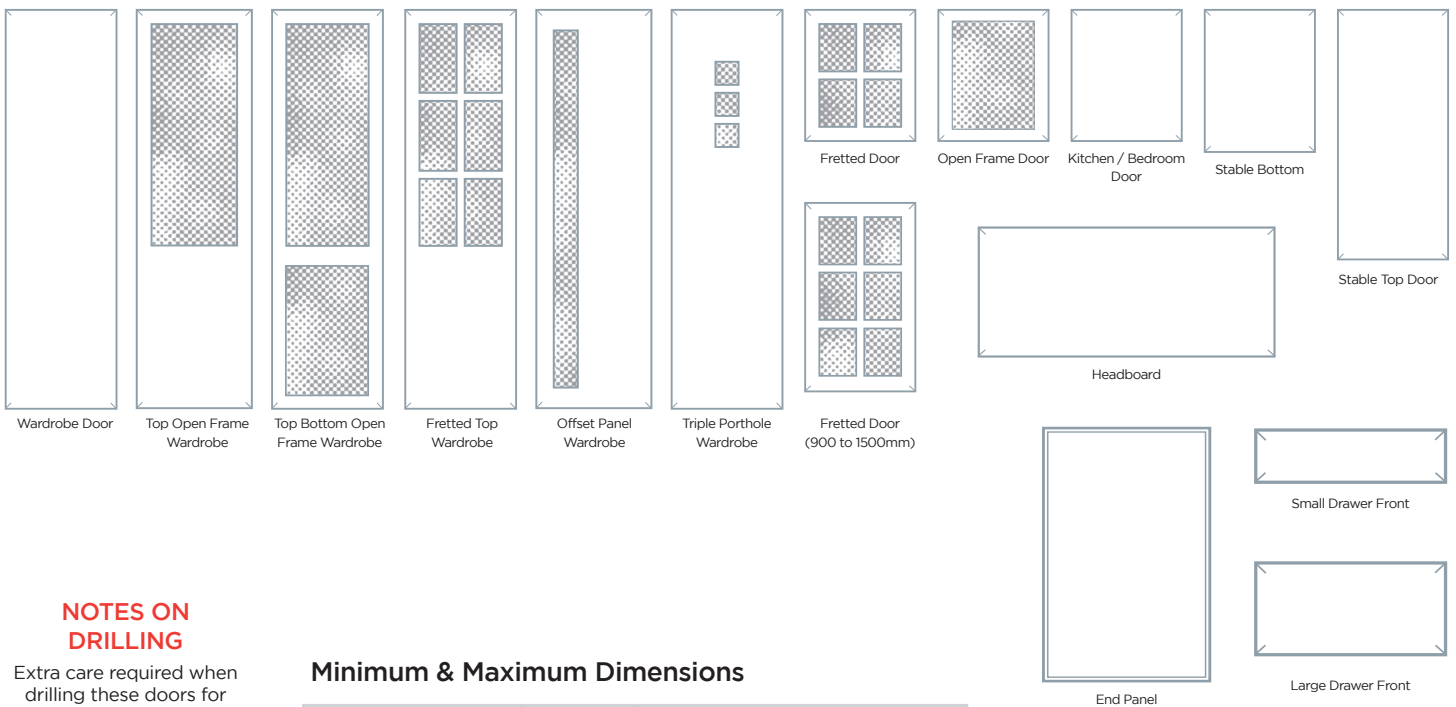

NOTES ON DRILLING

Extra care required when drilling these doors for hinges due to the doors edge thickness.
HPP cannot accept any responsibility if the door is drilled too deep

Minimum & Maximum Dimensions

Description	Min Height	Max Height	Min Width	Max Width
Drawer	100mm	355mm	140mm	1196mm
Door	285mm	2530mm	100mm	1196mm



S Standard Door Style

Metropole Door Specification

All drawer fronts horizontal grain	✓
Offset panel doors	✓
Triple porthole doors	✓
Matching panels	✓
Angled & truncated doors	✓
Special sizes	✓
Matching kitchen accessories	✓
Matching bedroom accessories	✓
Cornice, pelmet & plinth	✓

Style Variations

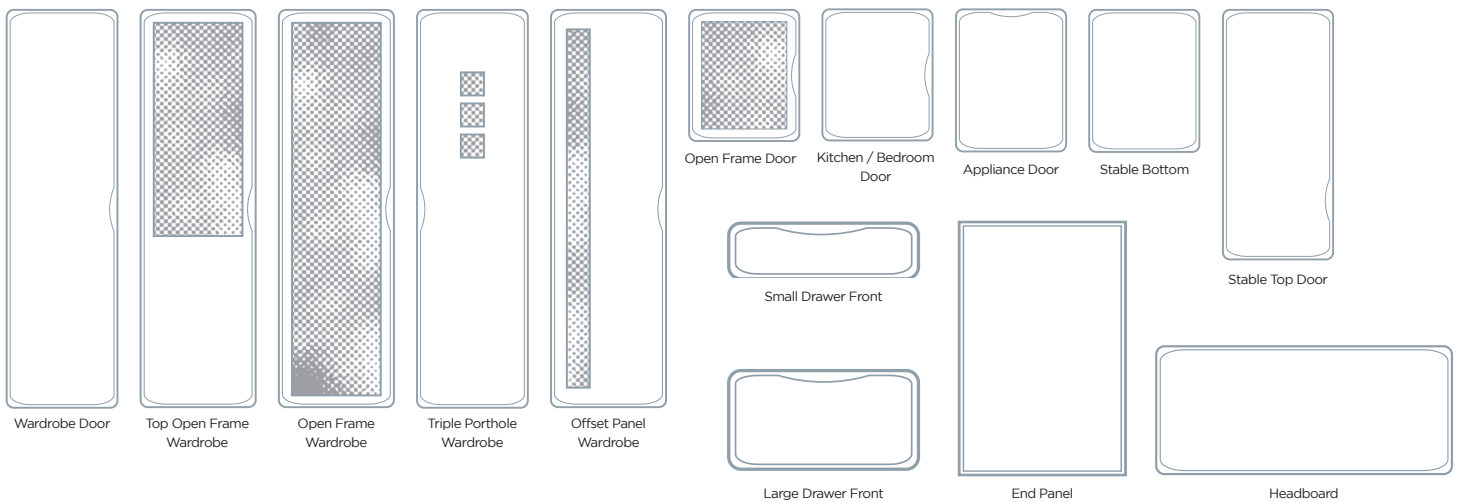

Minimum & Maximum Dimensions

Description	Min Height	Max Height	Min Width	Max Width
Drawer	100mm	355mm	140mm	1196mm
Door	285mm	2530mm	100mm	1196mm



S Standard Door Style

Milano Door Specification

All drawer fronts horizontal grain	✓
Offset panel doors	✓
Triple porthole doors	✓
Matching panels	✓
Angled & truncated doors	✓
Special sizes	✓
Matching kitchen accessories	✓
Matching bedroom accessories	✓
Cornice, pelmet & plinth	✓

Style Variations

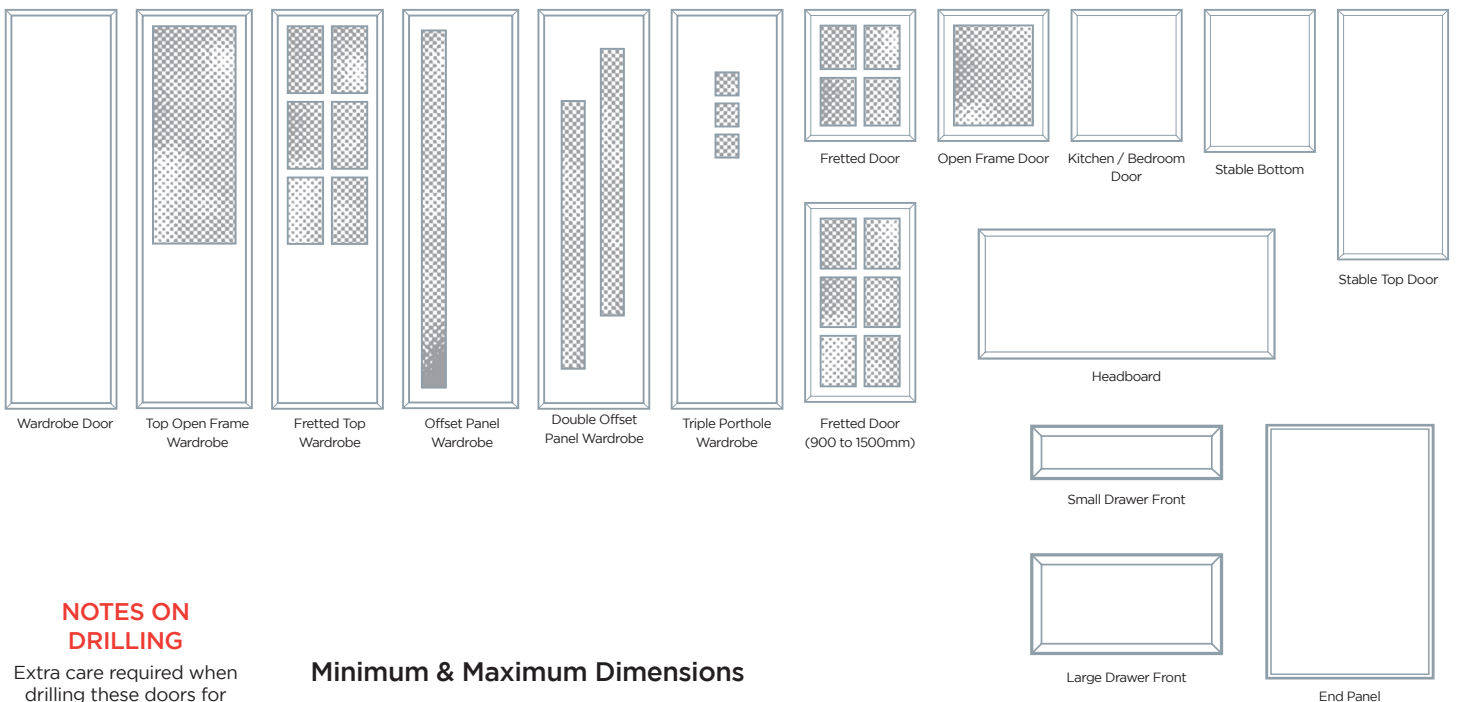

NOTES ON DRILLING

Extra care required when drilling these doors for hinges due to the doors edge thickness. HPP cannot accept any responsibility if the door is drilled too deep

Minimum & Maximum Dimensions

Description	Min Height	Max Height	Min Width	Max Width
Drawer	100mm	355mm	140mm	1196mm
Door	285mm	2530mm	100mm	1196mm



P Premium Door Style

New England Door Specification

All drawer fronts horizontal grain	✓
Offset panel doors	x
Triple porthole doors	x
Matching panels	✓
Angled & truncated doors	✓
Special sizes	✓
Matching kitchen accessories	✓
Matching bedroom accessories	✓
Cornice, pelmet & plinth	✓

Style Variations

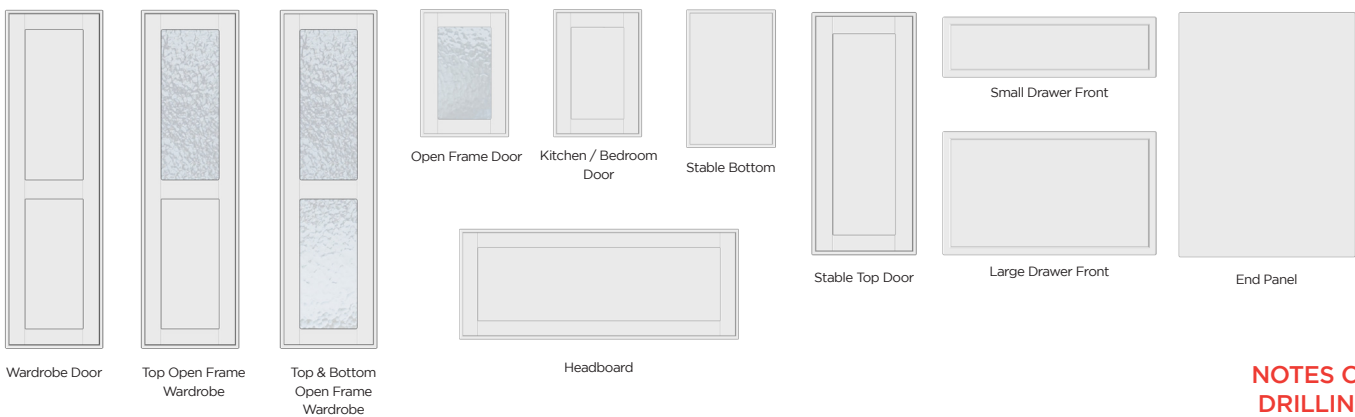

NOTES ON DRILLING

Extra care required when drilling these doors for hinges due to the doors edge thickness. HPP cannot accept any responsibility if the door is drilled too deep

PLAIN OR ROUTED DRAWER FRONTS

If you would like a routed centre panel in your drawers, please specify **"Drawer With Centre Panel"** when ordering or choose the **"Drawer With Centre Panel"** option when ordering online.

Minimum & Maximum Dimensions

Description	Min Height	Max Height	Min Width	Max Width	Notes
Drawer With Centre Panel	241mm	355mm	140mm	1196mm	
Drawer No Centre Panel	100mm	355mm	140mm	1196mm	
Door	275mm	2530mm	100mm	1196mm	Plain panel when width is less than 241mm



S Standard Door Style

New Fenland Door Specification

All drawer fronts horizontal grain	✓
Offset panel doors	✗
Triple porthole doors	✗
Matching panels	✓
Angled & truncated doors	✓
Special sizes	✓
Matching kitchen accessories	✓
Matching bedroom accessories	✓
Cornice, pelmet & plinth	✓

Style Variations

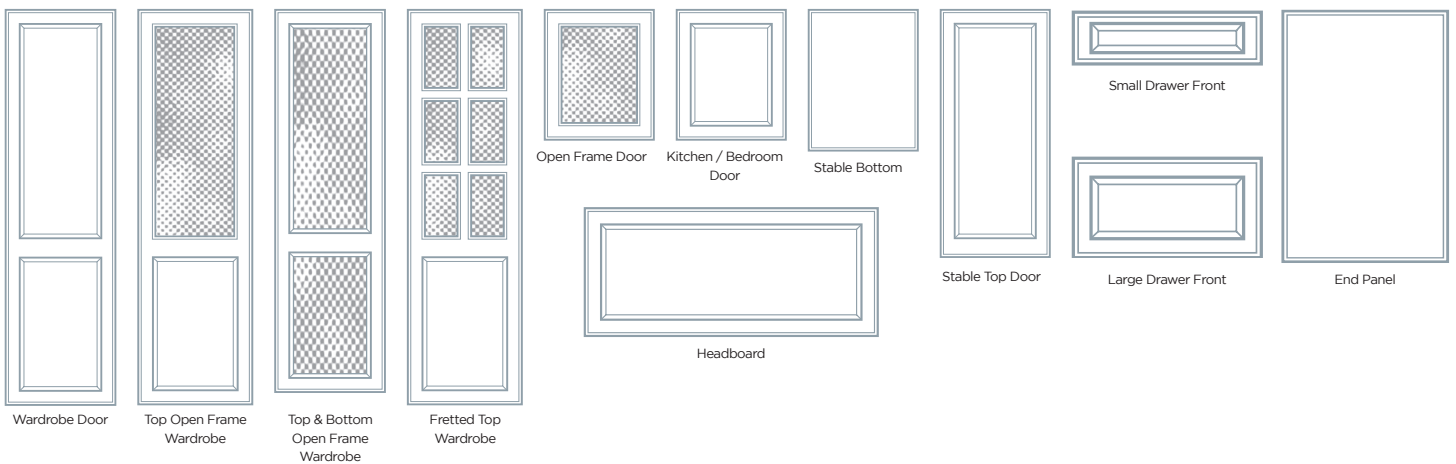

Wardrobe Door

Top Open Frame Wardrobe

Top & Bottom Open Frame Wardrobe

Fretted Top Wardrobe

Open Frame Door

Kitchen / Bedroom Door

Stable Bottom

Stable Top Door

Small Drawer Front

Large Drawer Front

End Panel

Headboard

Minimum & Maximum Dimensions

Description	Min Height	Max Height	Min Width	Max Width	Notes
Drawer	100mm	355mm	140mm	1196mm	Plain panel when height is less than 140mm.
Door	285mm	2530mm	100mm	1196mm	Plain panel when width is less than 195mm



S Standard Door Style

New Sudbury Door Specification

All drawer fronts horizontal grain	✓
Offset panel doors	x
Triple porthole doors	x
Matching panels	✓
Angled & truncated doors	✓
Special sizes	✓
Matching kitchen accessories	✓
Matching bedroom accessories	✓
Cornice, pelmet & plinth	✓

Style Variations

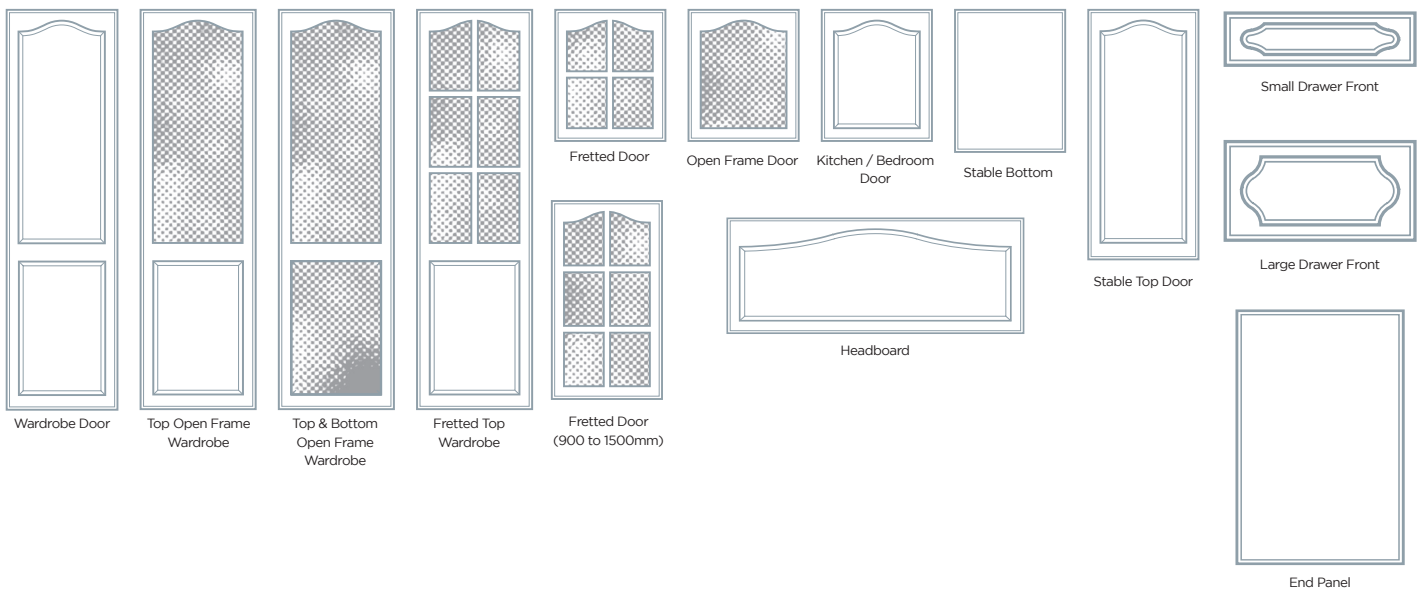

Minimum & Maximum Dimensions

Description	Min Height	Max Height	Min Width	Max Width	Notes
Drawer	100mm	355mm	140mm	1196mm	Plain panel when height is less than 140mm.
Door	285mm	2530mm	100mm	1196mm	Plain panel when width is less than 200mm.



P Premium Door Style

Nova Door Specification

All drawer fronts horizontal grain	✓
Offset panel doors	✗
Triple porthole doors	✗
Matching panels	✓
Angled & truncated doors	✓
Special sizes	✓
Matching kitchen accessories	✓
Matching bedroom accessories	✓
Cornice, pelmet & plinth	✓

Style Variations

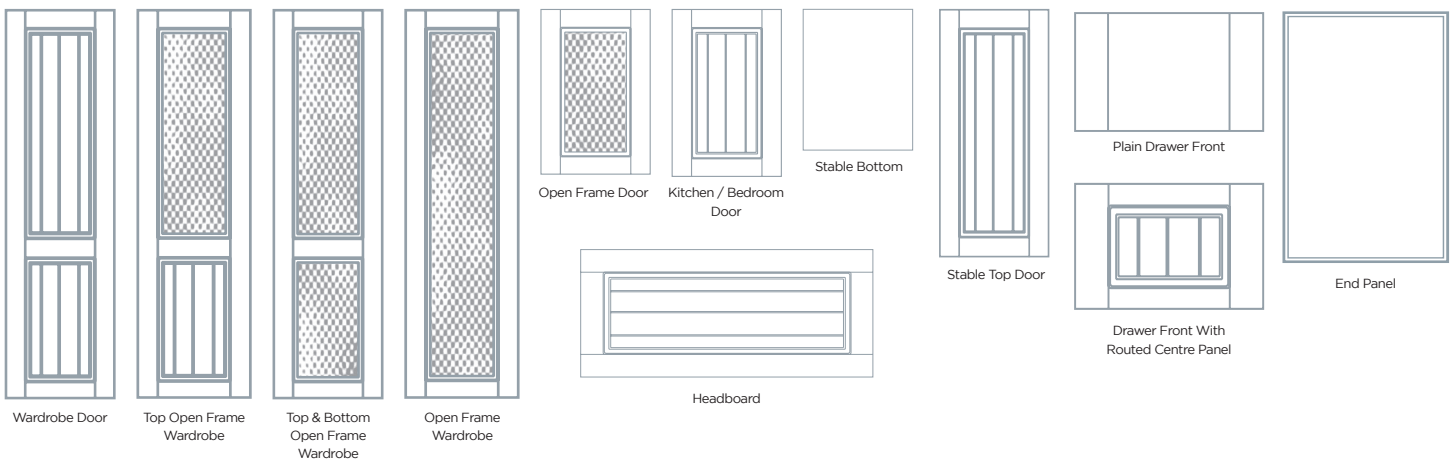

PLAIN OR ROUTED DRAWER FRONTS

If you would like a routed centre panel in your drawers, please specify **“Drawer With Centre Panel”** when ordering or choose the **“Drawer With Centre Panel”** option when ordering online.

Minimum & Maximum Dimensions

Description	Min Height	Max Height	Min Width	Max Width	Notes
Drawer With Centre Detail	241mm	355mm	140mm	1196mm	
Drawer No Centre Detail	100mm	355mm	140mm	1196mm	
Door	285mm	2530mm	100mm	1196mm	Plain panel with shaker lines when width is less than 220mm



S Standard Door Style

Oslo Door Specification

All drawer fronts horizontal grain	✓
Offset panel doors	✓
Triple porthole doors	✓
Matching panels	✓
Angled & truncated doors	✓
Special sizes	✓
Matching kitchen accessories	✓
Matching bedroom accessories	✓
Cornice, pelmet & plinth	✓

Style Variations

NOTES ON DRILLING
 Extra care required when drilling these doors for hinges due to the doors edge thickness.
 HPP cannot accept any responsibility if the door is drilled too deep

Minimum & Maximum Dimensions

Description	Min Height	Max Height	Min Width	Max Width
Drawer	100mm	355mm	140mm	1196mm
Door	285mm	2530mm	100mm	1196mm



- S** Premium Door Style
- W** 22mm Thickness & White Back

Palermo Door Specification

All drawer fronts horizontal grain	✓
Offset panel doors	✓
Triple porthole doors	✗
Matching panels	✓
Angled & truncated doors	✓
Special sizes	✓
Matching kitchen accessories	✓
Matching bedroom accessories	✓
Cornice, pelmet & plinth	✓

Style Variations

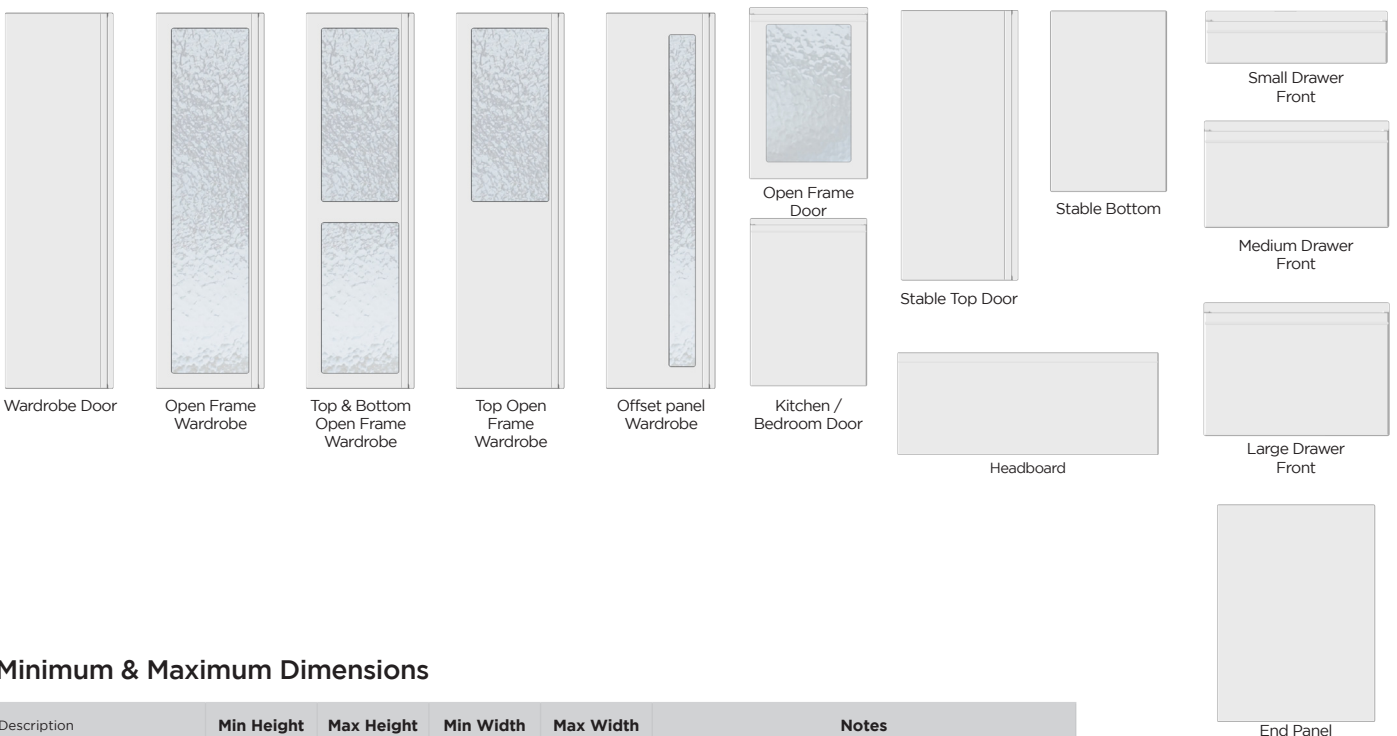

Minimum & Maximum Dimensions

Description	Min Height	Max Height	Min Width	Max Width	Notes
Drawer	100mm	355mm	140mm	1196mm	
Door	285mm	1700mm	100mm	1196mm	



S Standard Door Style

Pillow Door Specification

All drawer fronts horizontal grain	✓
Offset panel doors	✗
Triple porthole doors	✓
Matching panels	✓
Angled & truncated doors	✓
Special sizes	✓
Matching kitchen accessories	✓
Matching bedroom accessories	✓
Cornice, pelmet & plinth	✓

Style Variations

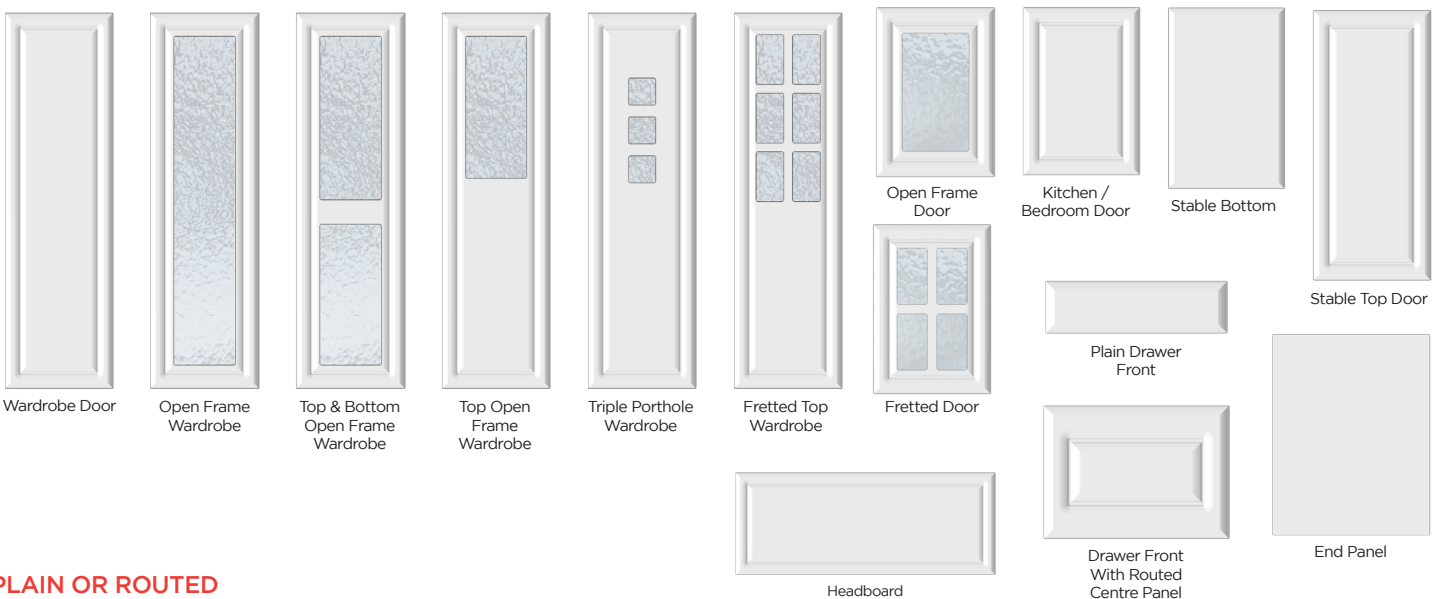

PLAIN OR ROUTED DRAWER FRONTS

If you would like a routed centre panel in your drawers, please specify **"Drawer With Centre Panel"** when ordering or choose the **"Drawer With Centre Panel"** option when ordering online.

Minimum & Maximum Dimensions

Description	Min Height	Max Height	Min Width	Max Width	Notes
Drawer	100mm	355mm	140mm	1196mm	Plain panel when height is less than 160mm or width is less than 180mm.
Door	285mm	2530mm	100mm	1196mm	Plain panel when width is less than 180mm

NOTES ON DRILLING

Extra care required when drilling these doors for hinges due to the doors edge thickness. HPP cannot accept any responsibility if the door is drilled too deep



S Standard Door Style

Ribble Door Specification

All drawer fronts horizontal grain	✓
Offset panel doors	✗
Triple porthole doors	✗
Matching panels	✓
Angled & truncated doors	✓
Special sizes	✓
Matching kitchen accessories	✓
Matching bedroom accessories	✓
Cornice, pelmet & plinth	✓

Style Variations



Minimum & Maximum Dimensions

Description	Min Height	Max Height	Min Width	Max Width	Notes
Drawer	100mm	355mm	140mm	1196mm	Plain panel when height is less than 140mm.
Door	285mm	2530mm	100mm	1196mm	Plain panel when width is less than 250mm.

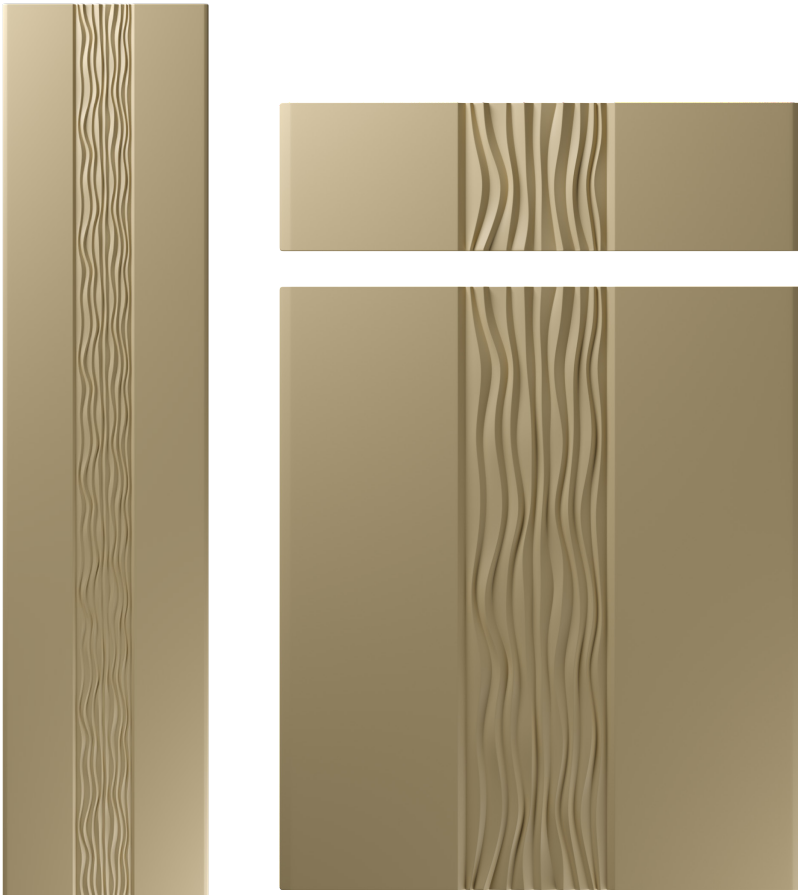

P Premium Door Style

Sahara Door Specification

All drawer fronts horizontal grain	✓
Offset panel doors	x
Triple porthole doors	x
Matching panels	✓
Angled & truncated doors	✓
Special sizes	✓
Matching kitchen accessories	✓
Matching bedroom accessories	✓
Cornice, pelmet & plinth	✓

Style Variations

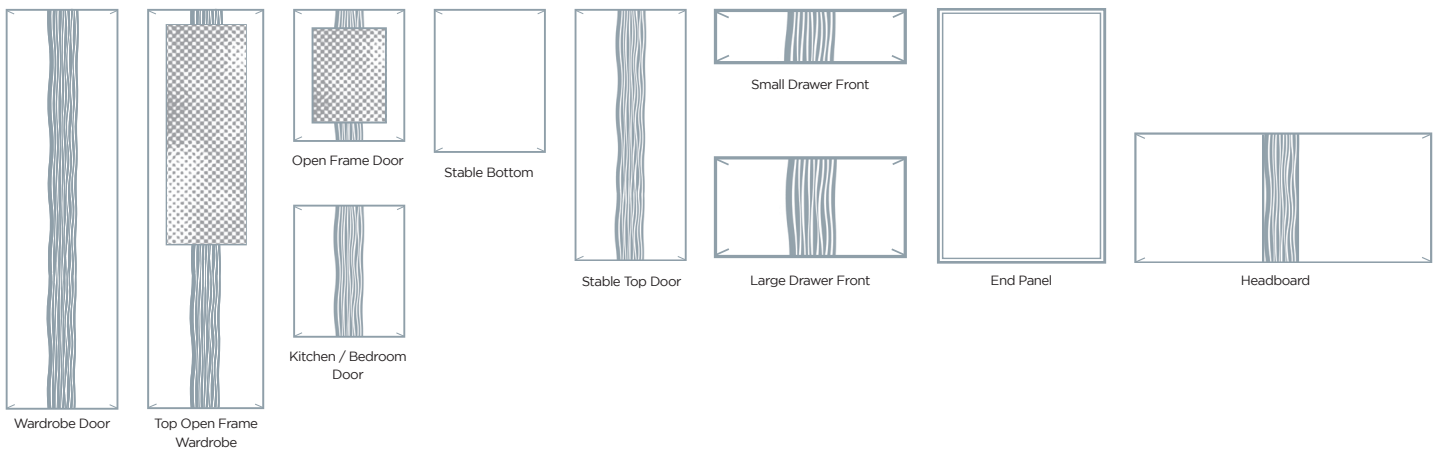

NOTES ON DRILLING

Extra care required when drilling these doors for hinges due to the doors edge thickness.
HPP cannot accept any responsibility if the door is drilled too deep

Minimum & Maximum Dimensions

Description	Min Height	Max Height	Min Width	Max Width	Notes
Drawer	100mm	355mm	140mm	1196mm	
Door	285mm	2530mm	100mm	1196mm	Plain panel when width is less than 240mm



S Standard Door Style

Scoop Door Specification

All drawer fronts horizontal grain	✓
Offset panel doors	✓
Triple porthole doors	✓
Matching panels	✓
Angled & truncated doors	✓
Special sizes	✓
Matching kitchen accessories	✓
Matching bedroom accessories	✓
Cornice, pelmet & plinth	✓

Style Variations

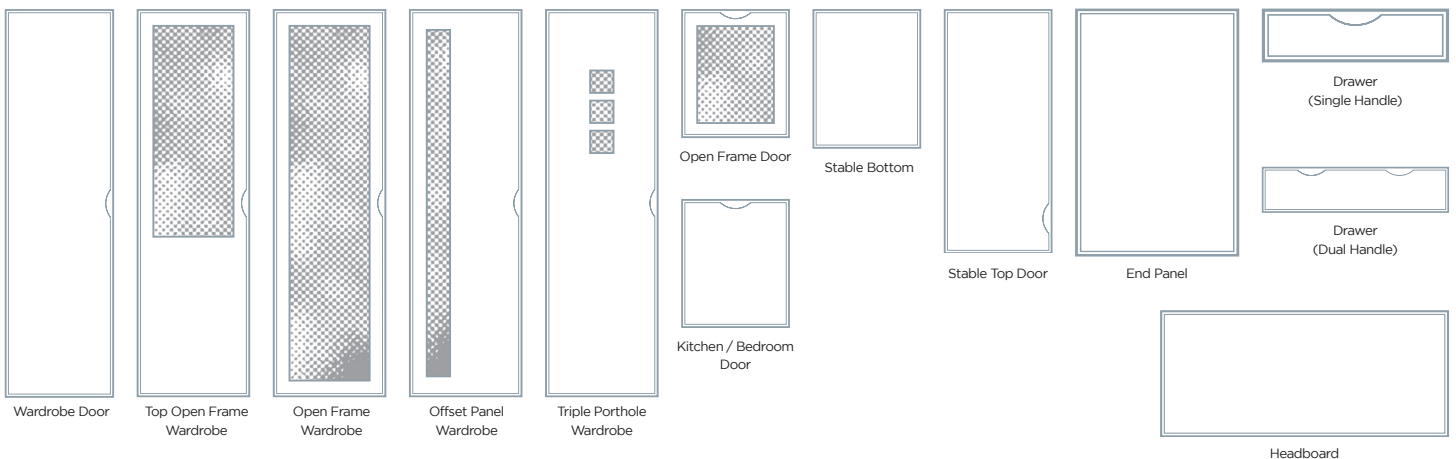

Minimum & Maximum Dimensions

Description	Min Height	Max Height	Min Width	Max Width	Notes
Drawer (Single Handle)	100mm	355mm	270mm	1196mm	Scoop handles sold separately.
Drawer (Dual Handle)	100mm	355mm	546mm	1196mm	Scoop handles sold separately.
Door	285mm	1700mm	270mm	1196mm	Scoop handles sold separately.

Drawer Front Widths & Handles

No Handle		One Handle		Two Handles	
From	0mm	From	270mm	From	600mm
To	269mm	To	599mm	To	1196mm

These are the default widths for 1 & 2 handle Scoop drawer fronts if the number of handles isn't explicitly specified when ordering.



S Standard Door Style

Severn Door Specification

All drawer fronts horizontal grain	✓
Offset panel doors	✓
Triple porthole doors	✓
Matching panels	✓
Angled & truncated doors	✓
Special sizes	✓
Matching kitchen accessories	✓
Matching bedroom accessories	✓
Cornice, pelmet & plinth	✓

Style Variations

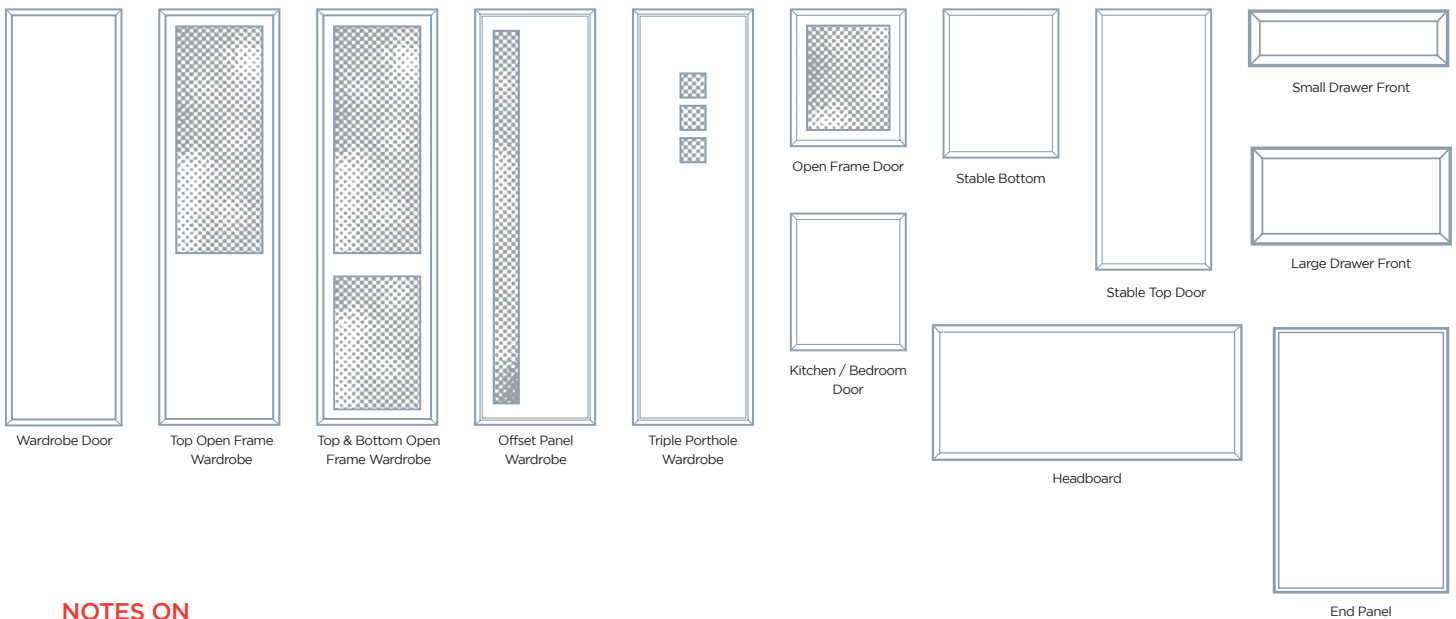

NOTES ON DRILLING

Extra care required when drilling these doors for hinges due to the doors edge thickness.
HPP cannot accept any responsibility if the door is drilled too deep

Minimum & Maximum Dimensions

Description	Min Height	Max Height	Min Width	Max Width
Drawer	100mm	355mm	140mm	1196mm
Door	285mm	2530mm	100mm	1196mm



P Premium Door Style

Shaker Door Specification

All drawer fronts horizontal grain	✓
Offset panel doors	✗
Triple porthole doors	✗
Matching panels	✓
Angled & truncated doors	✓
Special sizes	✓
Matching kitchen accessories	✓
Matching bedroom accessories	✓
Cornice, pelmet & plinth	✓

Style Variations

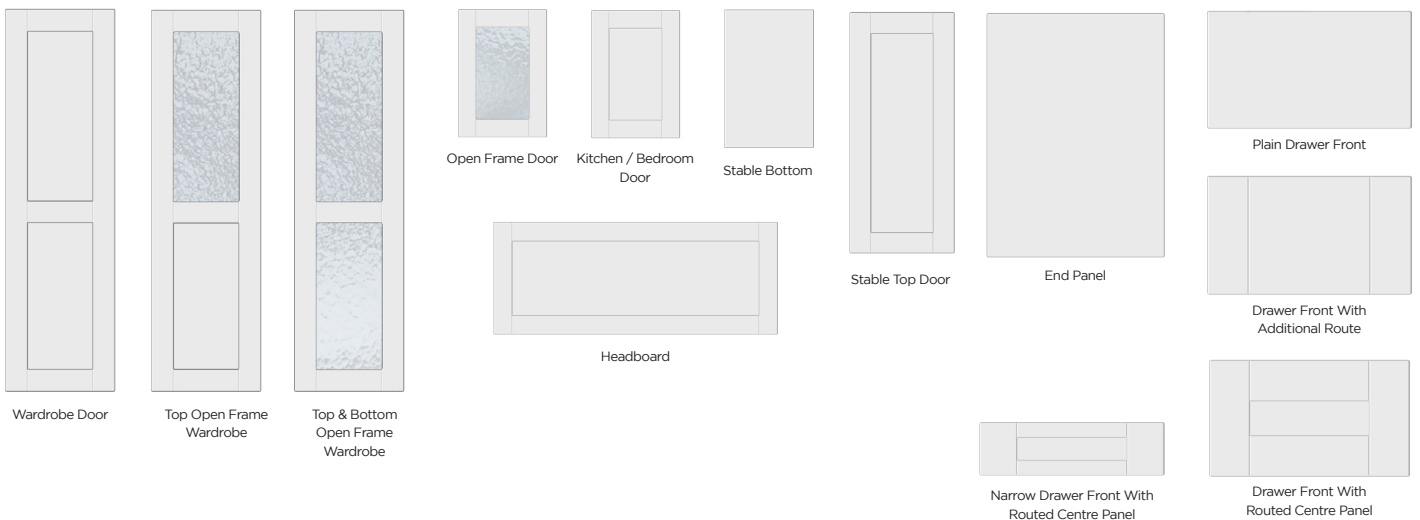

PLAIN OR ROUTED DRAWER FRONTS
 If you would like a routed centre panel in your drawers, please specify **“Drawer With Centre Panel”**, **“Narrow Drawer With Centre Panel”** or **“Drawer with Additional Route”** when ordering or choose the appropriate option when ordering online.

Minimum & Maximum Dimensions

Description	Min Height	Max Height	Min Width	Max Width	Notes
Drawer With Centre Panel	241mm	355mm	241mm	1196mm	
Narrow Drawer With Centre Panel	110mm	355mm	241mm	1196mm	Narrow top and bottom stiles (40mm)
Drawer With Additional Route	100mm	355mm	241mm	1196mm	
Drawer No Centre Panel	100mm	355mm	140mm	1196mm	
Door	241mm	2530mm	100mm	1196mm	Plain panel when width is less than 241mm



P Premium Door Style

Sutton Door Specification

All drawer fronts horizontal grain	✓
Offset panel doors	✗
Triple porthole doors	✗
Matching panels	✓
Angled & truncated doors	✓
Special sizes	✓
Matching kitchen accessories	✓
Matching bedroom accessories	✓
Cornice, pelmet & plinth	✓

Style Variations

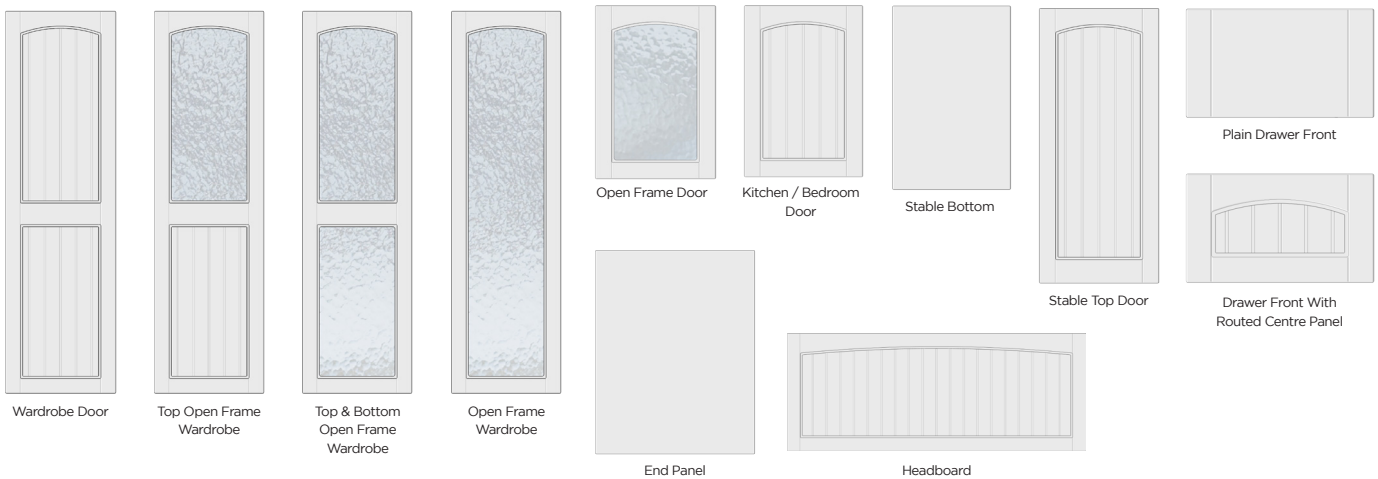

PLAIN OR ROUTED DRAWER FRONTS

If you would like a routed centre panel in your drawers, please specify **"Drawer With Centre Panel"** when ordering or choose the **"Drawer With Centre Panel"** option when ordering online.

Minimum & Maximum Dimensions

Description	Min Height	Max Height	Min Width	Max Width	Notes
Drawer With Centre Panel	241mm	355mm	140mm	1196mm	
Drawer	100mm	355mm	140mm	1196mm	
Door	285mm	2530mm	100mm	1196mm	Plain panel when width is less than 200mm



P Premium Door Style

Treviso Door Specification

All drawer fronts horizontal grain	✓
<i>Skinny</i> style with 60mm narrow frame	✓
Offset panel doors	✗
Triple porthole doors	✗
Matching panels	✓
Angled & truncated doors	✓
Special sizes	✓
Matching kitchen accessories	✓
Matching bedroom accessories	✓
Cornice, pelmet & plinth	✓

Style Variations

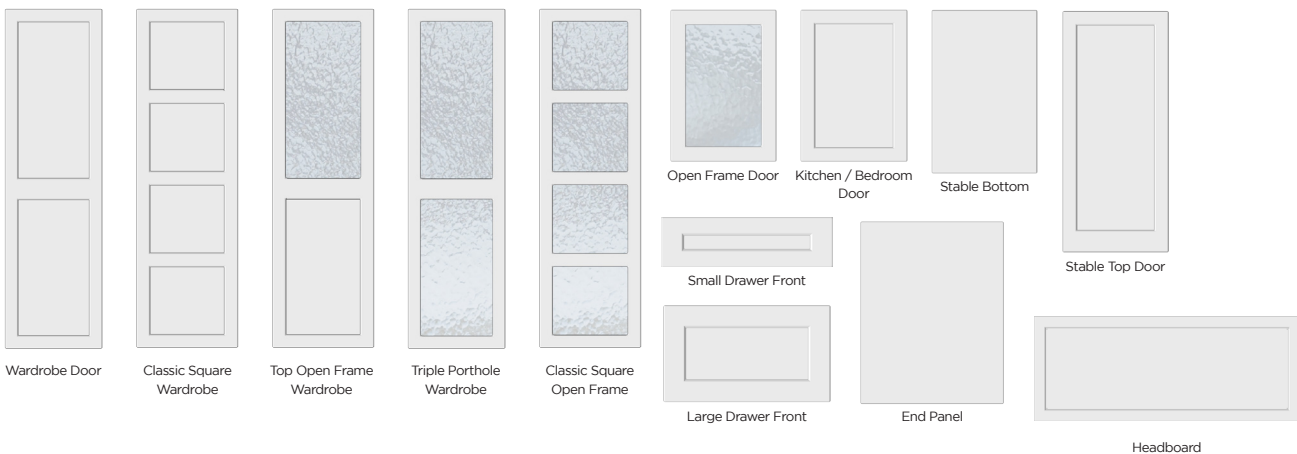

Minimum & Maximum Dimensions

Description	Min Height	Max Height	Min Width	Max Width	Notes
Drawer	100mm	355mm	140mm	1196mm	When height is between 140mm to 169mm, frame height is 45mm instead of 60mm. Plain panel when height is less than 140mm or width is less than 160mm.
Door	285mm	2530mm	100mm	1196mm	Plain panel when width is less than 160mm



S Standard Door Style

Turin Door Specification

All drawer fronts horizontal grain	✓
Offset panel doors	✓
Triple porthole doors	✓
Matching panels	✓
Angled & truncated doors	✓
Special sizes	✓
Matching kitchen accessories	✓
Matching bedroom accessories	✓
Cornice, pelmet & plinth	✓

Style Variations

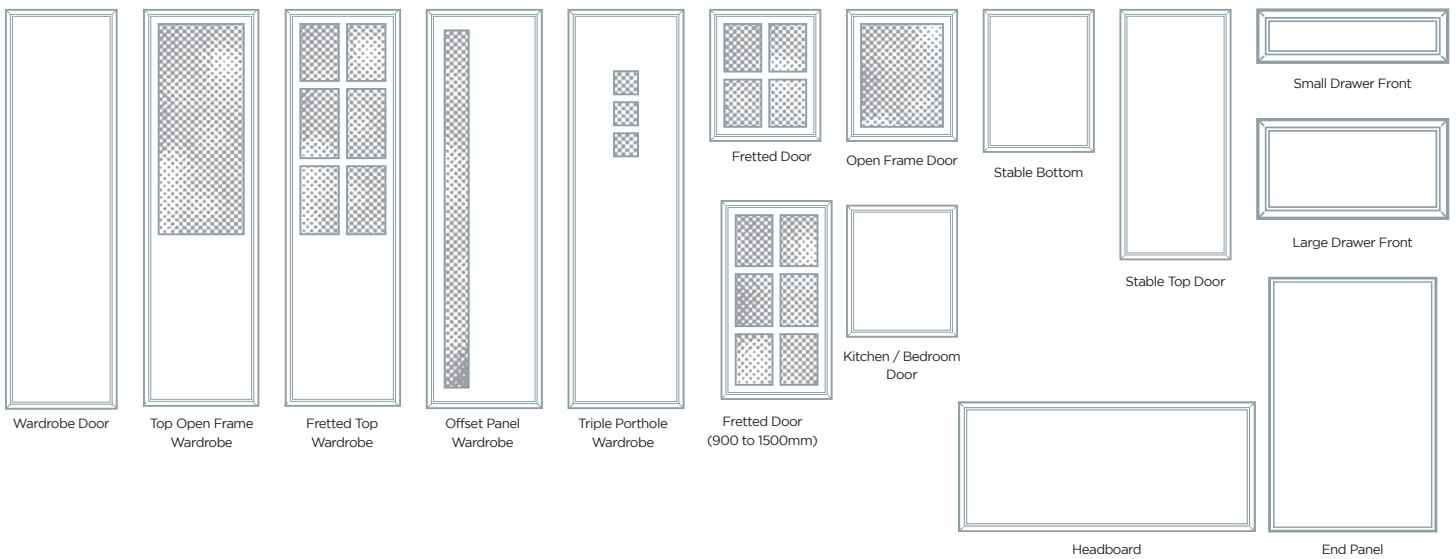

NOTES ON DRILLING

Extra care required when drilling these doors for hinges due to the doors edge thickness.
HPP cannot accept any responsibility if the door is drilled too deep

Minimum & Maximum Dimensions

Description	Min Height	Max Height	Min Width	Max Width	Notes
Drawer	100mm	355mm	140mm	1196mm	Plain panel when height is less than 140mm.
Door	285mm	2530mm	100mm	1196mm	Plain panel when width is less than 140mm



S Standard Door Style

Twinline Door Specification

All drawer fronts horizontal grain	✓
Offset panel doors	✓
Triple porthole doors	✓
Matching panels	✓
Angled & truncated doors	✓
Special sizes	✓
Matching kitchen accessories	✓
Matching bedroom accessories	✓
Cornice, pelmet & plinth	✓

Style Variations

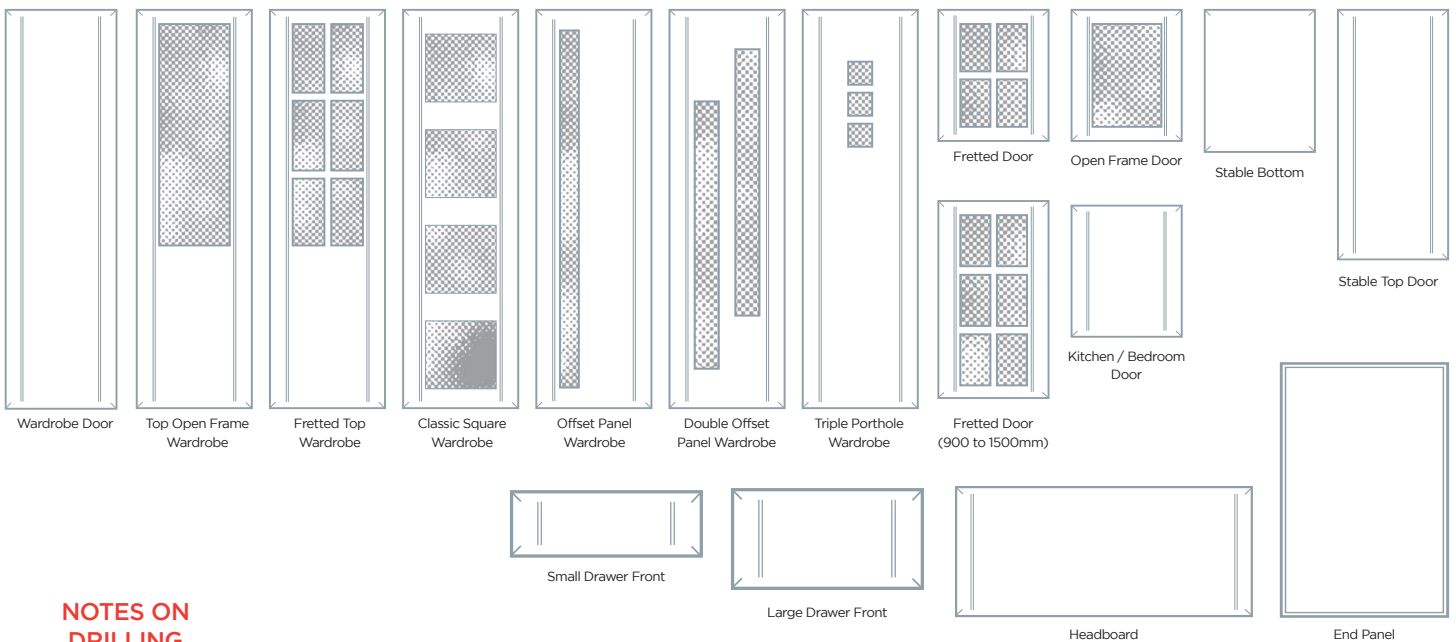

NOTES ON DRILLING

Extra care required when drilling these doors for hinges due to the doors edge thickness. HPP cannot accept any responsibility if the door is drilled too deep

Minimum & Maximum Dimensions

Description	Min Height	Max Height	Min Width	Max Width	Notes
Drawer	100mm	355mm	140mm	1196mm	
Door	285mm	2530mm	100mm	1196mm	Plain panel when width is less than 170mm



P Premium Door Style

Valencia Door Specification

All drawer fronts horizontal grain	✓
<i>Skinny</i> style with 60mm narrow frame	✓
Offset panel doors	✗
Triple porthole doors	✗
Matching panels	✓
Angled & truncated doors	✓
Special sizes	✓
Matching kitchen accessories	✓
Matching bedroom accessories	✓
Cornice, pelmet & plinth	✓

Style Variations

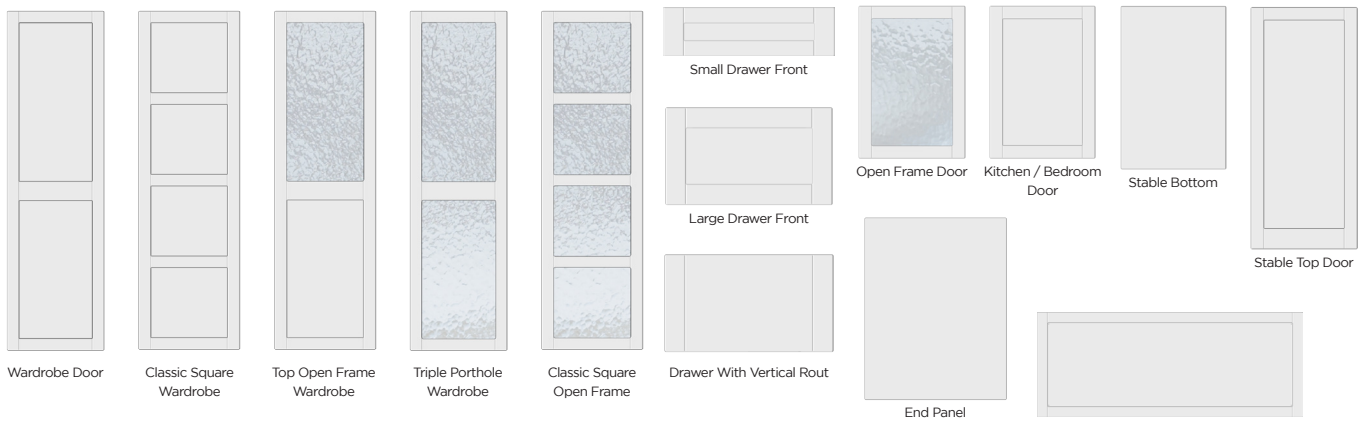

Minimum & Maximum Dimensions

Description	Min Height	Max Height	Min Width	Max Width	Notes
Drawer With Full Rout	100mm	355mm	140mm	1196mm	When height is between 140mm to 169mm, frame height is 45mm instead of 60mm. Plain panel when height is less than 140mm or width is less than 147mm.
Drawer With Vertical Rout	100mm	355mm	140mm	1196mm	
Door	285mm	2530mm	100mm	1196mm	Plain panel when width is less than 147mm

ROUTED DRAWER FRONT OPTIONS

Valencia drawer fronts can be ordered with a rout all round or with a vertical rout only. Please specify which option you would like when ordering.



S Standard Door Style

Verona Door Specification

All drawer fronts horizontal grain	✓
Offset panel doors	✓
Triple porthole doors	✓
Matching panels	✓
Angled & truncated doors	✓
Special sizes	✓
Matching kitchen accessories	✓
Matching bedroom accessories	✓
Cornice, pelmet & plinth	✓

Style Variations

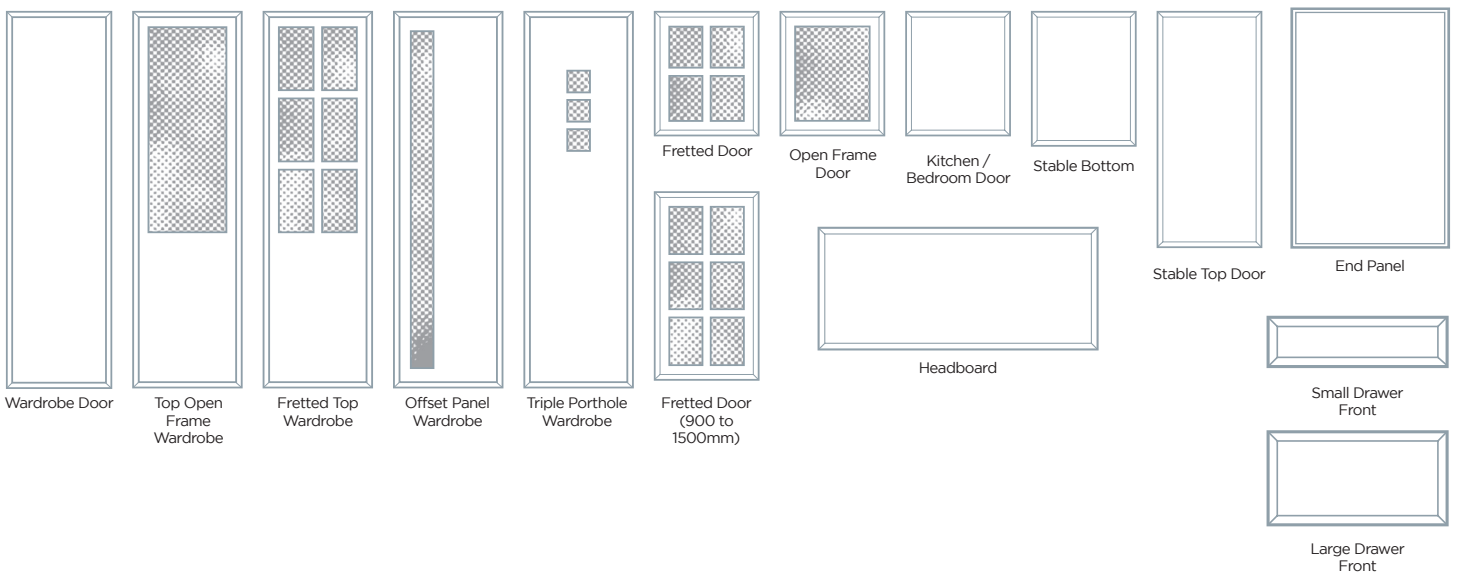

NOTES ON DRILLING
 Extra care required when drilling these doors for hinges due to the doors edge thickness.
 HPP cannot accept any responsibility if the door is drilled too deep

Minimum & Maximum Dimensions

Description	Min Height	Max Height	Min Width	Max Width
Drawer	100mm	355mm	140mm	1196mm
Door	285mm	2530mm	100mm	1196mm



S Standard Door Style

Vienna Door Specification

All drawer fronts horizontal grain	✓
Offset panel doors	✓
Triple porthole doors	✓
Matching panels	✓
Angled & truncated doors	✓
Special sizes	✓
Matching kitchen accessories	✓
Matching bedroom accessories	✓
Cornice, pelmet & plinth	✓

Style Variations

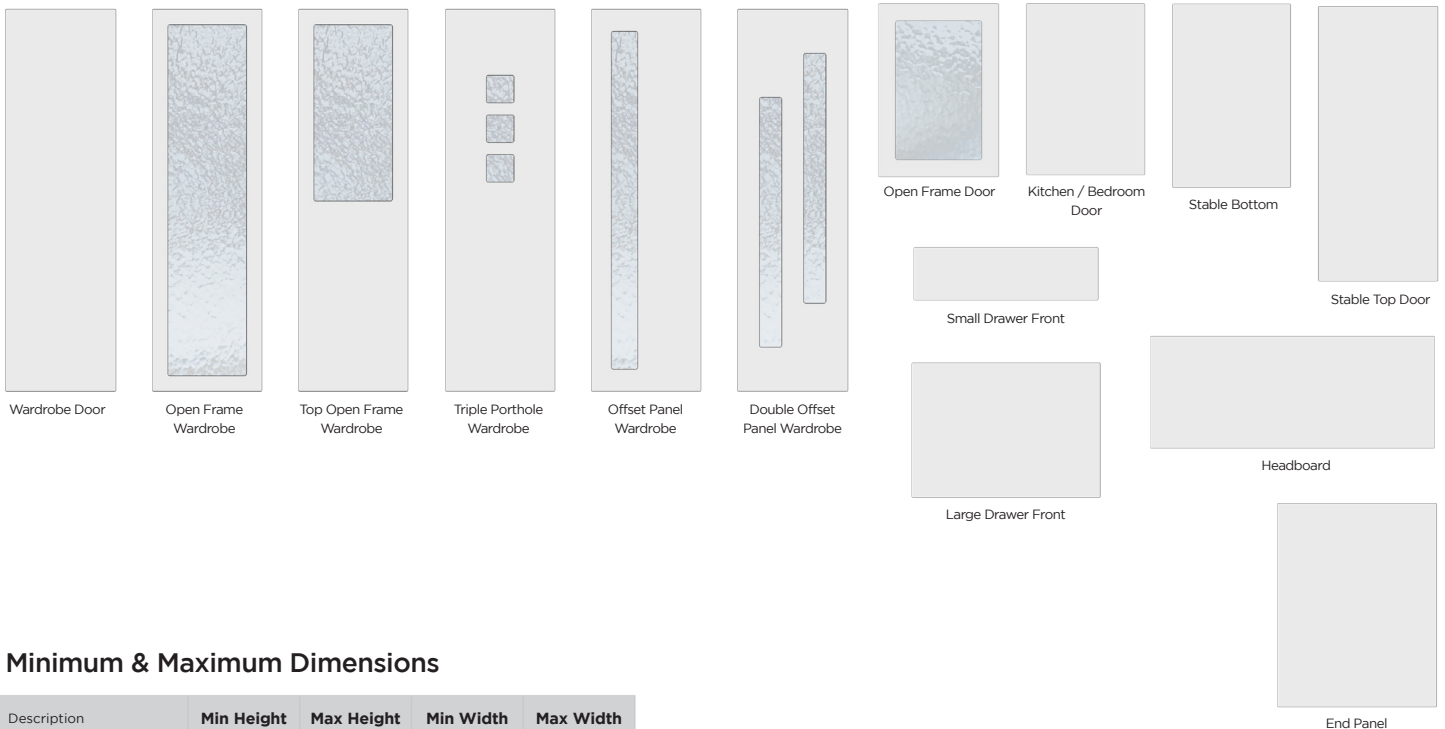

Minimum & Maximum Dimensions

Description	Min Height	Max Height	Min Width	Max Width
Drawer	100mm	355mm	140mm	1196mm
Door	285mm	2530mm	100mm	1196mm



S Standard Door Style

Willingdale Door Specification

All drawer fronts horizontal grain	✓
Offset panel doors	✗
Triple porthole doors	✗
Matching panels	✓
Angled & truncated doors	✓
Special sizes	✓
Matching kitchen accessories	✓
Matching bedroom accessories	✓
Cornice, pelmet & plinth	✓

Style Variations

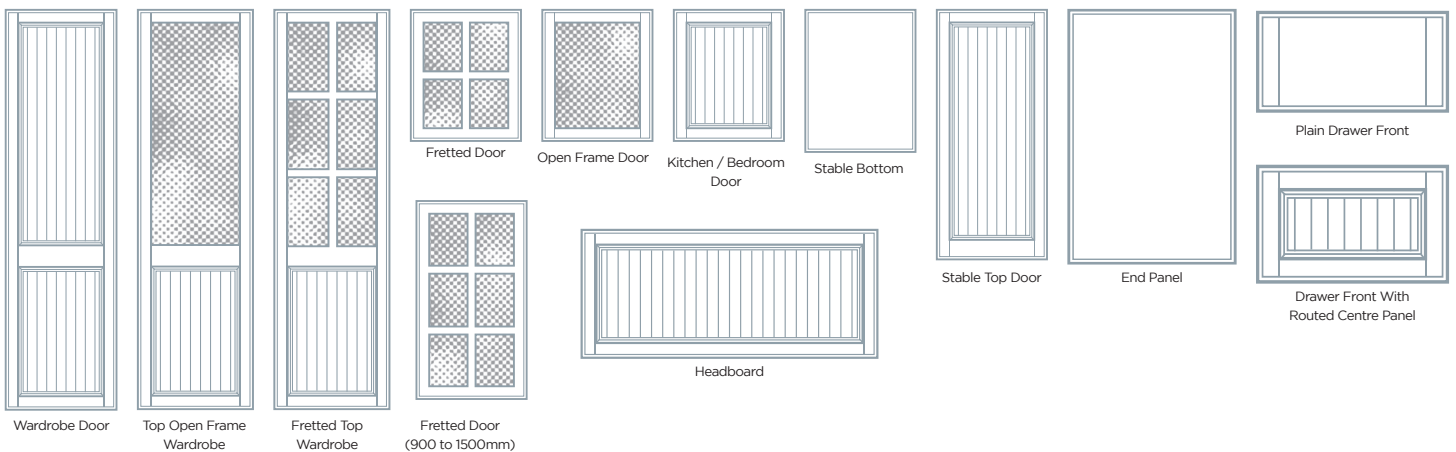

PLAIN OR ROUTED DRAWER FRONTS

If you would like a routed centre panel in your drawers, please specify **"Drawer With Centre Panel"** when ordering or choose the **"Drawer With Centre Panel"** option when ordering online.

Minimum & Maximum Dimensions

Description	Min Height	Max Height	Min Width	Max Width	Notes
Drawer With Centre Detail	241mm	355mm	140mm	1196mm	
Drawer No Centre Detail	100mm	355mm	140mm	1196mm	
Door	285mm	2530mm	100mm	1196mm	Plain panel when width is less than 200mm



S Standard Door Style

Winwick Door Specification

All drawer fronts horizontal grain	✓
Offset panel doors	✓
Triple porthole doors	✓
Matching panels	✓
Angled & truncated doors	✓
Special sizes	✓
Matching kitchen accessories	✓
Matching bedroom accessories	✓
Cornice, pelmet & plinth	✓

Style Variations

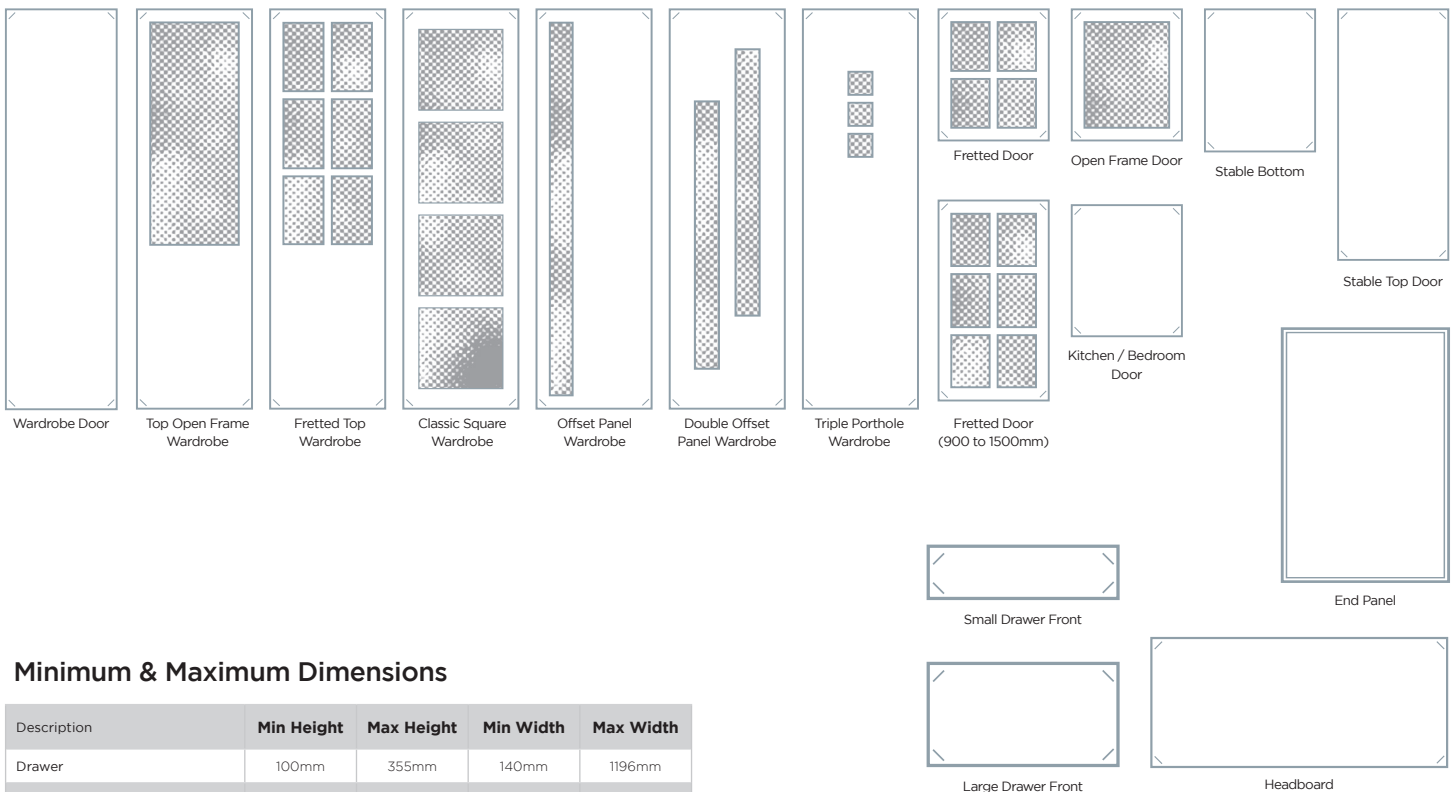

Minimum & Maximum Dimensions

Description	Min Height	Max Height	Min Width	Max Width
Drawer	100mm	355mm	140mm	1196mm
Door	285mm	2530mm	100mm	1196mm

Drawer Route Options

Some door styles offer an optional centre panel, narrow (40mm) top & bottom stiles or an additional route. If the centre panel, narrow drawer option or additional route is required, this must be stated when ordering.

If no drawer route option is stated when ordering, a plain / standard drawer front will be supplied.

Please refer to the style pages for maximum and minimum dimensions where optional routes are available.

Plain Drawer Front

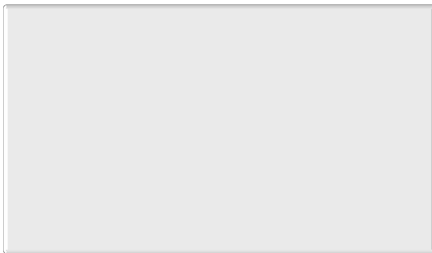

Drawer With Centre Panel

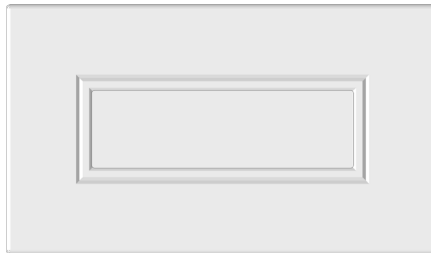

Drawer With Additional Route

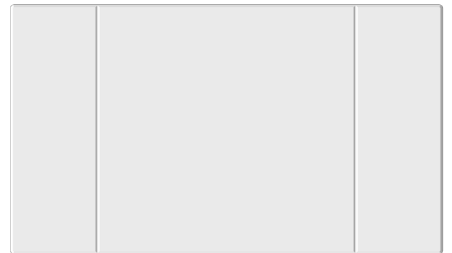

Narrow Drawer Front

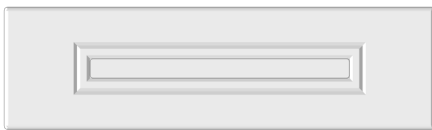

The **narrow drawer front** option enables selected styles to still have a centre route down to a minimum height of 140mm by reducing the height of the top and bottom stiles to 40mm.

Ordering Bi-Fold Doors

When ordering bi-fold doors, make sure you order your left and right doors as if you are stood looking at them.

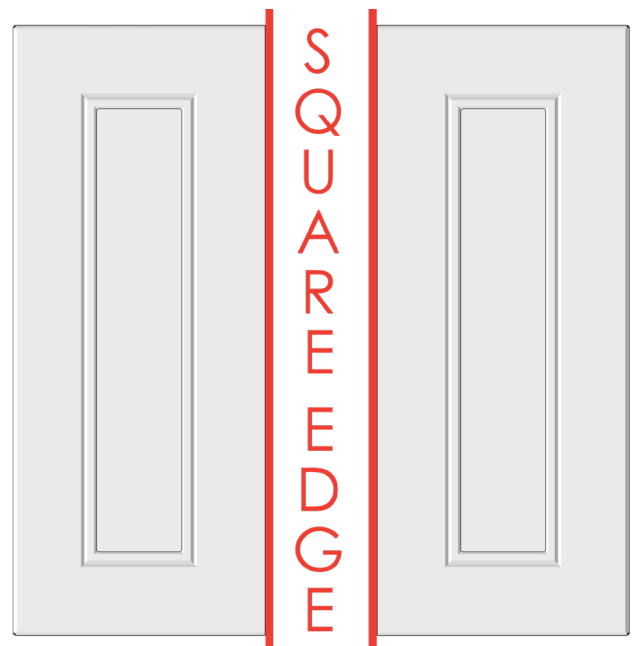

Order As
Bi-Fold Door Left
(Code: BFDL)

Order As
Bi-Fold Door Right
(Code: BFDR)

Made-To-Measure With Ready Fitted Handles

- Made-to-measure with your choice of handle already fitted.
- Available in a variety of finishes such as Brushed Nickel, Chrome & Matt Chrome.
- All available in the full range of décors.
- All available as angled, truncated & glazed doors.

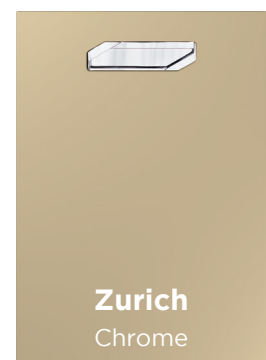
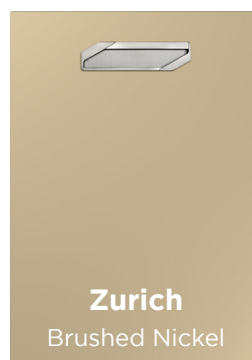
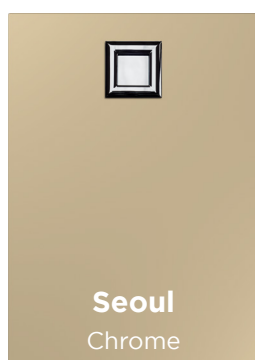
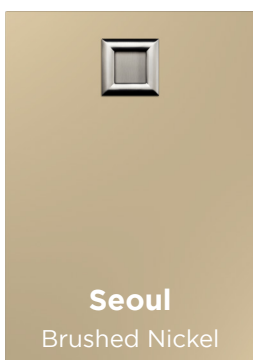
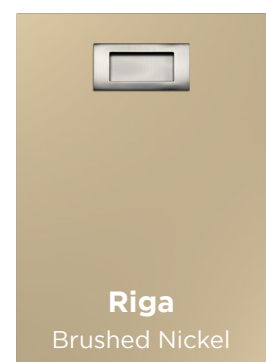
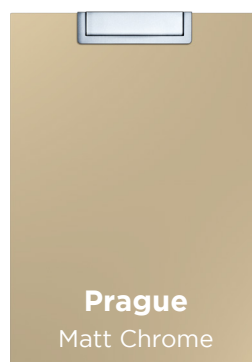
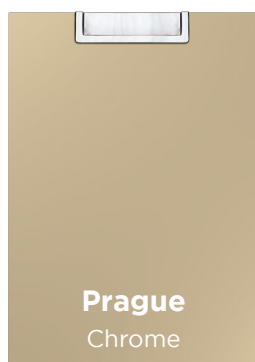
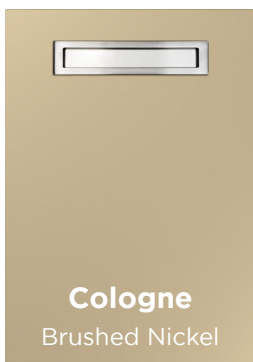

Glass Colours & Notes On Drilling

All of our non-glazed framed doors come with a removable back seal so silicone is not required to fit your own glass.

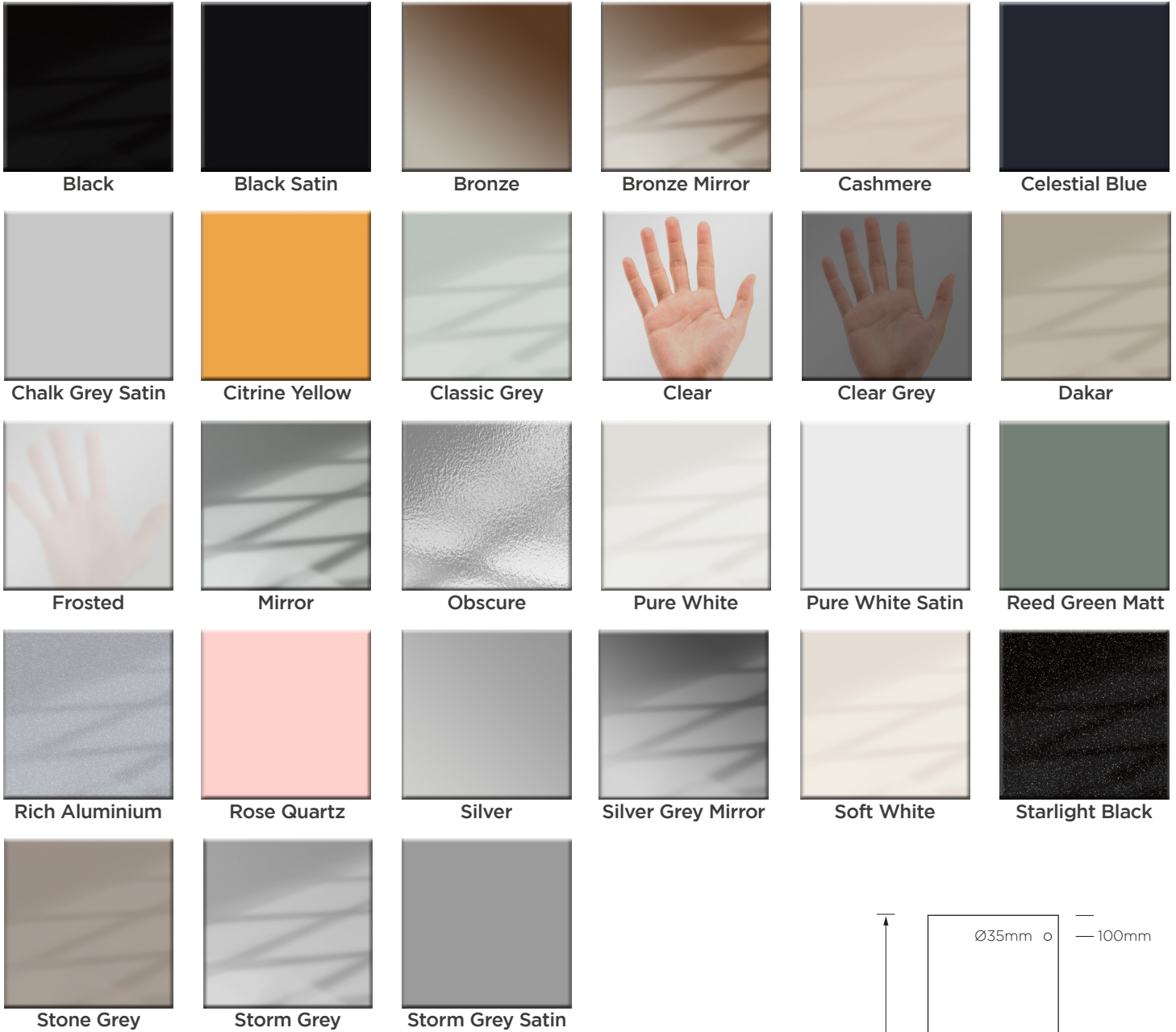

Drilling

Doors are available drilled 100mm from the top and bottom. On larger doors the extra holes are divided equally between the remaining space.

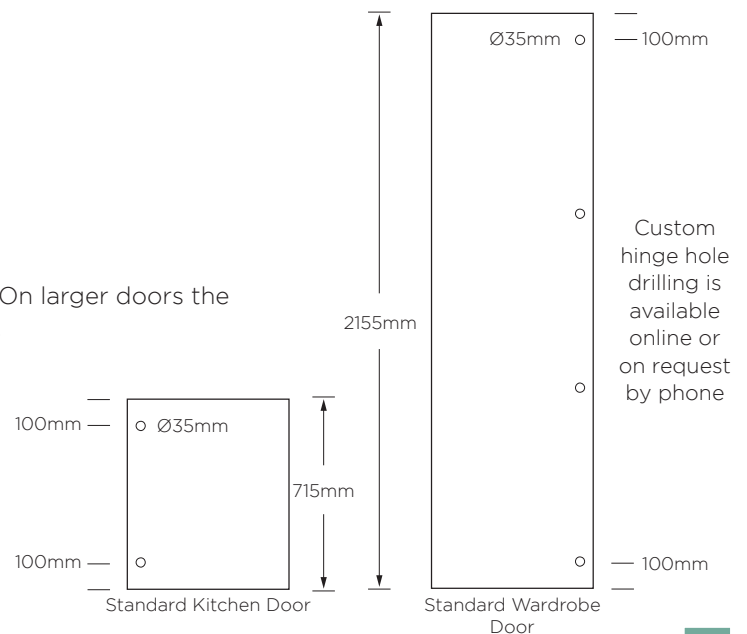
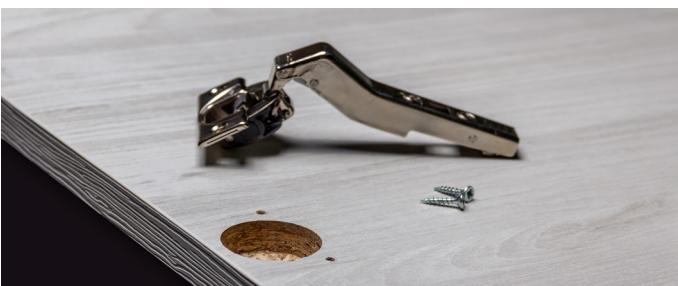

Vinyl Wrapped Accessories

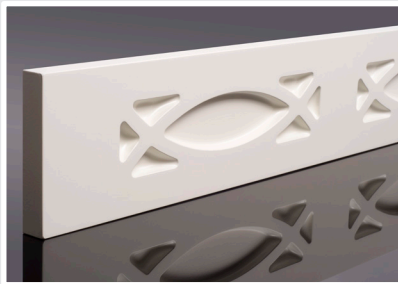

	Size (mm)
Fretted frieze	600x100
Fretted frieze	1200x100
Fretted frieze	2400x100



	Size (mm)
Plinths	Up to 2400 x 150



Tongue & Groove Panel
Used for kitchen end panels. Made-to-measure

Wine Racks



Wine Rack Panels & Fascias
Made-to-measure up to 2400mm



Fluted Pilasters



	Size (mm)
Fluted pilaster	Any height up to 2400mm x 100mm width

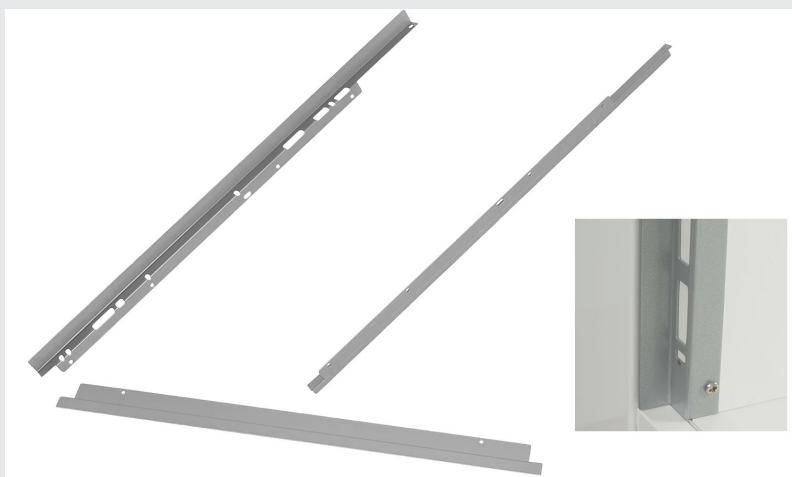

Heat Deflectors

	Product Code
2 x Side / 1 x Lower Kit	563.80.951
Sides: 634mm / Lower: 596mm	

Lower Heat Deflector
Designed for use at the bottom of any appliance giving off heat.

Side Heat Deflectors - Pair
Designed for use at the side of any appliance giving off heat. For use with 18/19mm carcass.

Modern Canopies

Canopy

Widths

600mm

700mm

800mm

900mm

1000mm

1100mm

1200mm

INCLUDES:

2 Sides, 1 Shelf & 1 Vienna Profile Door.

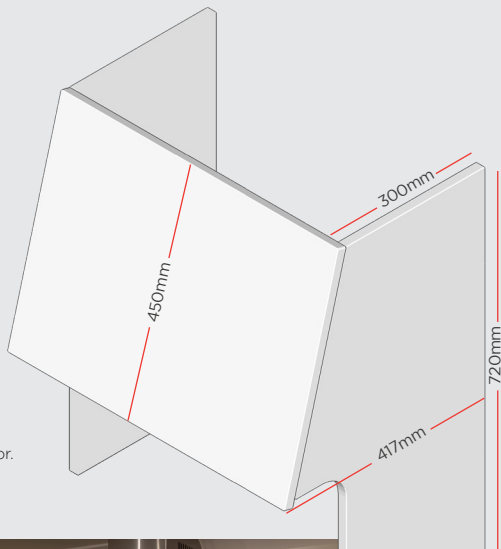

Modern canopies are available with a Vienna edge profile and in any Aspire décor
 Note: Requires 90 degree fittings to assemble, for example modesty blocks

Rounded Pilaster

Available in 2.4m lengths.



Open End Units

Available as base or wall units

Available as wall or base units and as left or right handed units in any vinyl wrapped décor

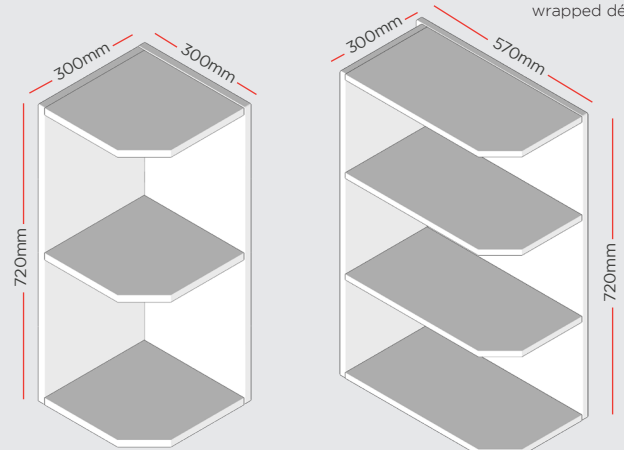

Architrave & Skirting Boards

Available in 2.4m lengths in matching edge profiles or in a Torus design.

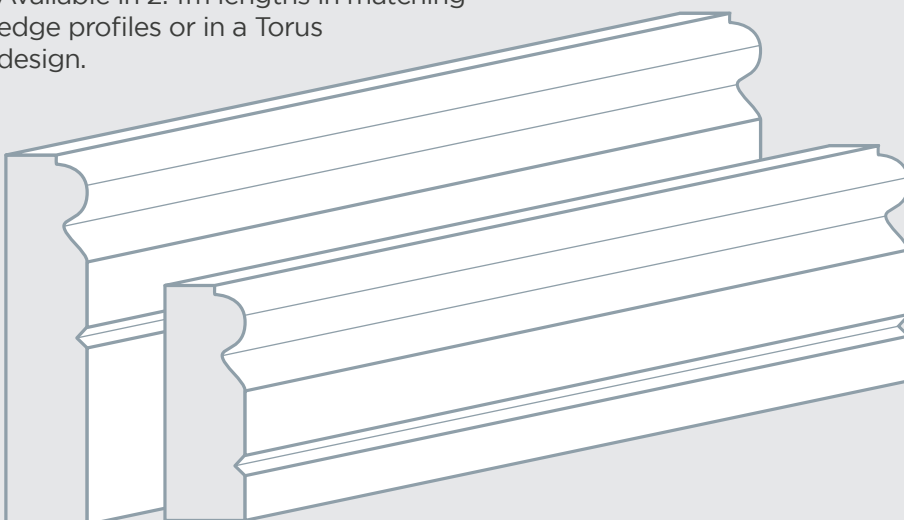

All accessories are available in any of our vinyl décors.

Mirrors



Arched Triple Mirror (Available in standard profile only)



Square Triple Mirror (Available to match any of our Aspire door profiles)

Headboards

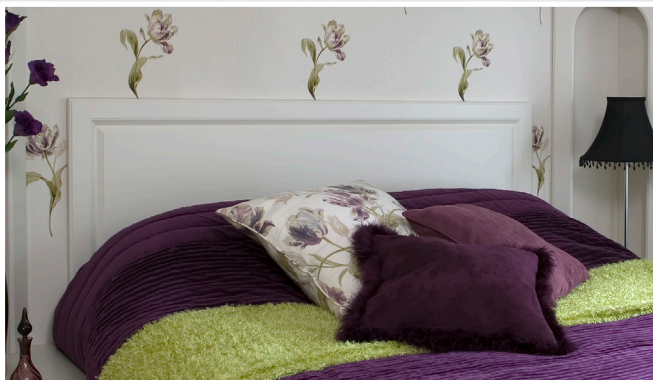

	Size (mm)
Headboard	3ft (915mm)
Headboard	3ft 6ins (1066mm)
Headboard	4ft 6ins (1371mm)
Headboard	5ft (1523mm)

Featured headboards (right) available in Boston, Chedburgh & New Sudbury styles.

Matching square headboards also available in any of our Aspire door profiles. See door style pages for more details



Boston



Chedburgh



New Sudbury

Finishing Touches



Niche Front



Pilaster



Fretted Frieze

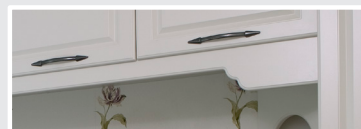

Bridging Pelmet



Keystone

Niche Front
Made to measure up to 2400mm

	Size (mm)
Fretted frieze	600x100
Fretted frieze	1200x100
Fretted frieze	2400x100

Bridging pelmets from 500 up to 2400mm are supplied as 1 piece
Bridging pelmets 2400mm & over are supplied in 2 pieces (left & right)
Keystone (to cover bridging pelmet joint) one size
Pilasters can be ordered in any size up to 100x2400mm

Vinyl Wrapped Mirrors

Available in three sizes in a matching edge profile or a feature design.

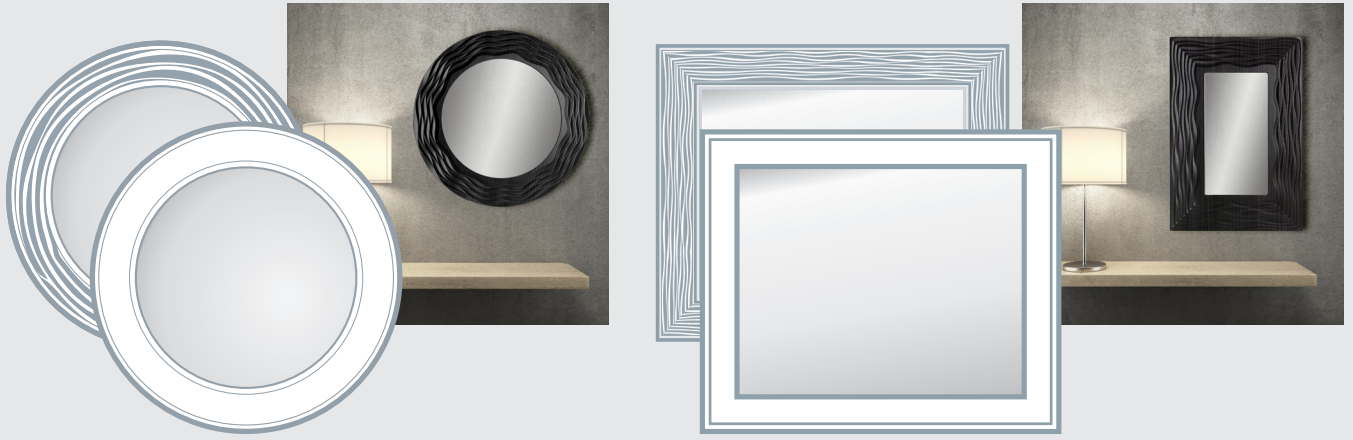

Padded Stools

Available with a variety of pad finishes in Dralon or Faux Leather. Frame only option also available.



Traditional Stools



Swivel Mirrors

Available with or without wings.

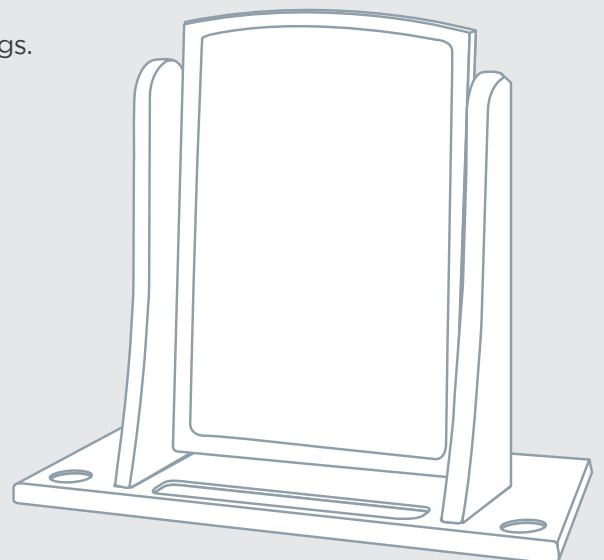

22mm and 25mm Panels

When ordering any 22mm thick components, the back will be white rather than matching the décor on the front.

When ordering any 25mm thick components, the back will be Montana Oak rather than matching the décor on the front.

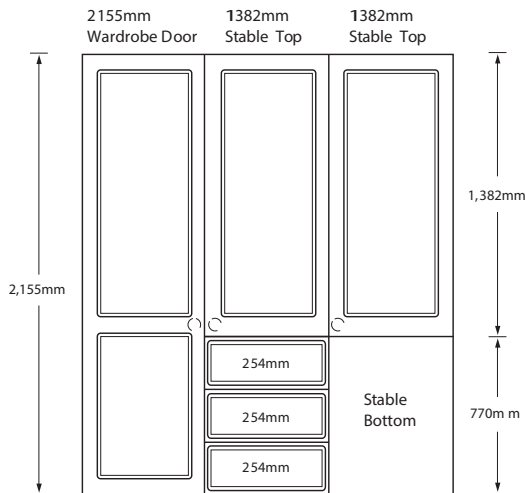

Standard wardrobe and drawer combination

Stable Doors

Stable door bottoms are always 770mm in height in order to line up with cross rails, you must order as a Stable bottom. Stable door tops have a 98mm bottom rail to match the depth of the cross rails on wardrobe doors. Always ensure you use the words 'Stable Door' in your description or they will be made as normal doors and will not line up. If ordering larger or smaller doors, change the height of the Stable top door not the bottom items.

Worktops

When ordering worktops you must always quote the worktop code and supply a diagram showing the size required, direction of the grain, edges to be profiled and type of profile. If no profile is specified the standard one will be sent.

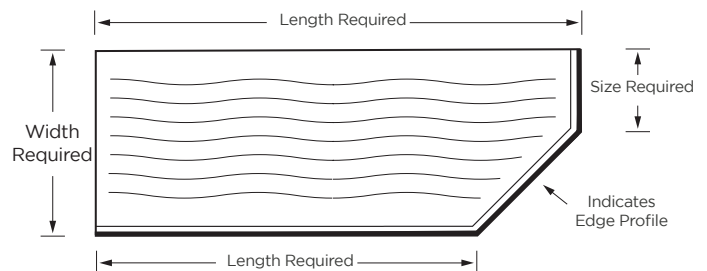

Worktop Edged All Round



Worktop Edged on Front



Worktop Edged on Front & Left



Worktop Edged on Front & Right



Worktop Edged on Front, Right & Left



Left Angled Worktop Edged on Front



Left Angled Worktop Edged on Front & Left



Left Angled Worktop Edged on Front & Right



Left Angled Worktop Edged on Front, Right & Left



Right Angled Worktop Edged on Front



Right Angled Worktop Edged on Front & Left



Right Angled Worktop Edged on Front & Right



Right Angled Worktop Edged on Front, Right & Left

Drawer Route Options

Some door styles offer an optional centre panel, narrow (40mm) top & bottom stiles or an additional route. If the centre panel, narrow drawer option or additional route is required, this must be stated when ordering.

If no drawer route option is stated when ordering, a plain / standard drawer front will be supplied.

Please refer to the style pages for maximum and minimum dimensions where optional routes are available.

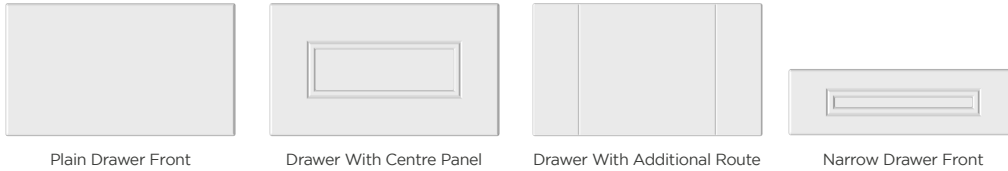

The **narrow drawer front** option enables selected styles to still have a centre route down to a minimum height of 140mm by reducing the height of the top and bottom stiles to 40mm.

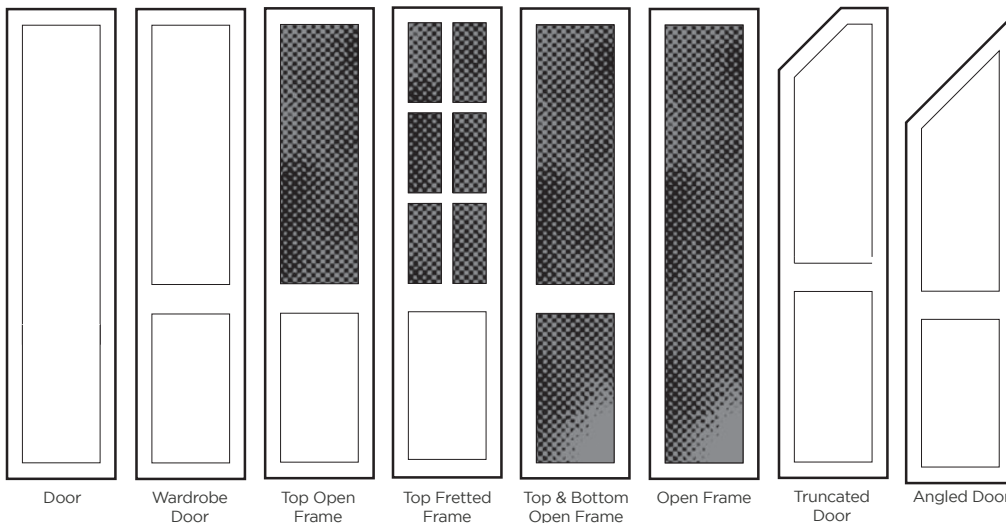

Wardrobe Doors

These will include a cross rail on doors over 1700mm in height, if this is not required please specify no centre rail when ordering.

Doors

These can be made up to a maximum of 2400mm in height and 1196mm in width. All Shaker drawer fronts will be plain unless ordered as doors.

Glass Openings

Top fretted wardrobe doors will have 6 openings on doors 2155mm high or less and 8 openings on all doors 2156mm and above. Fretted doors under 900mm in height will have 4 openings. 900 - 1500mm will have 6 openings. All our glass opening doors are supplied with internal beading.

Angled Doors

Please supply a diagram including measurements for the width and heights on both sides of the door.

Note: Depending on the door style and angles some angled doors will not have a continued rout pattern

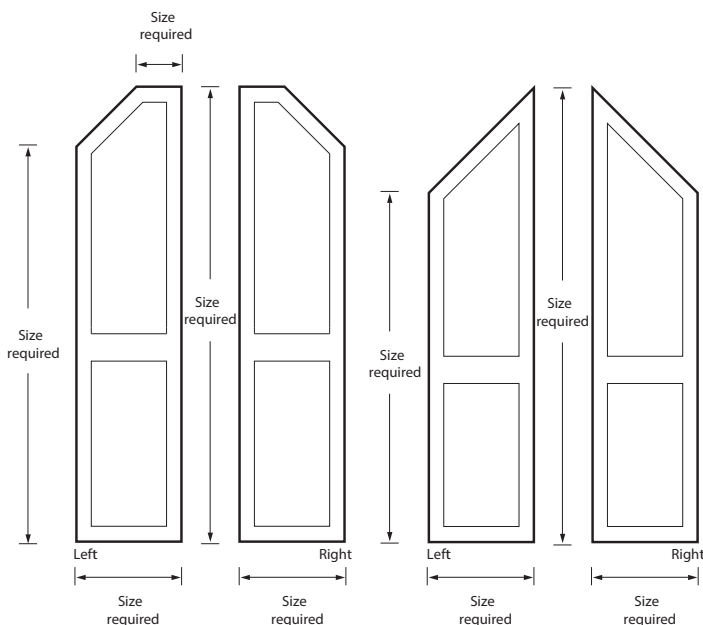

Customer Care Information

The Vinyl Door Collection has been tested and certified by FIRA as achieving the bond quality requirements of BS6222 part III, however there are still some recommendations that all end users must be made aware of. To avoid damage by excessive heat please follow the simple guidelines below during installation and subsequent use:

When installing doors adjacent to ovens always ensure that doors are shielded by using heat deflector strips. Never use any appliance which generates high levels of heat or concentrated steam (such as a toaster, kettle or pressure cooker) directly under or adjacent to a vinyl wrapped component. For cleaning use a damp cloth and a non-abrasive domestic cleaner. Failure to use heat strips next to appliances could invalidate your guarantee.

This customer care information does not affect your statutory rights.



make it **happen**

Aspire Trade Guide

January 2025

Aspire Trade Guide

Aspire Trade Guide

Aspire Trade Guide

Aspire Trade Guide