

ZMM.0380 BOXFIX E-T

ML

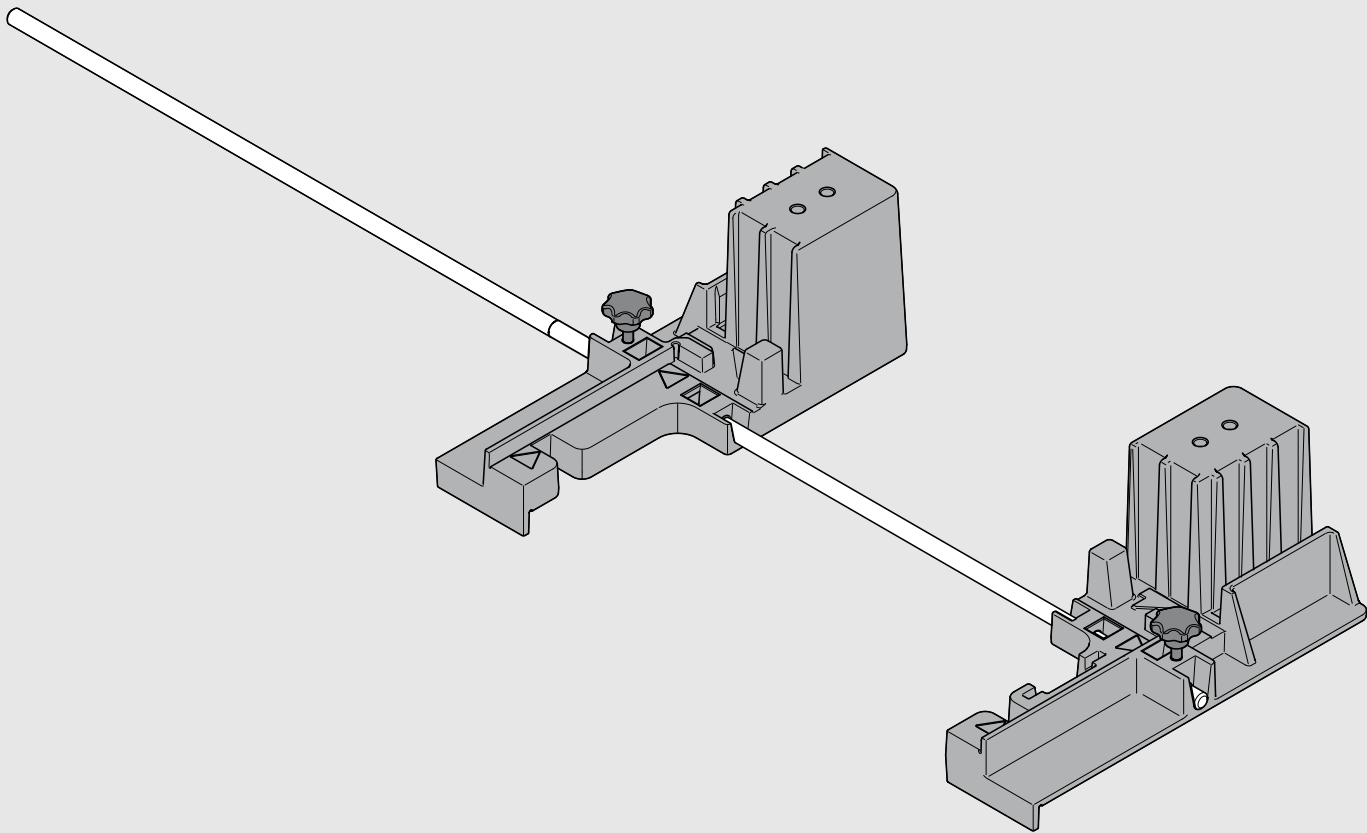

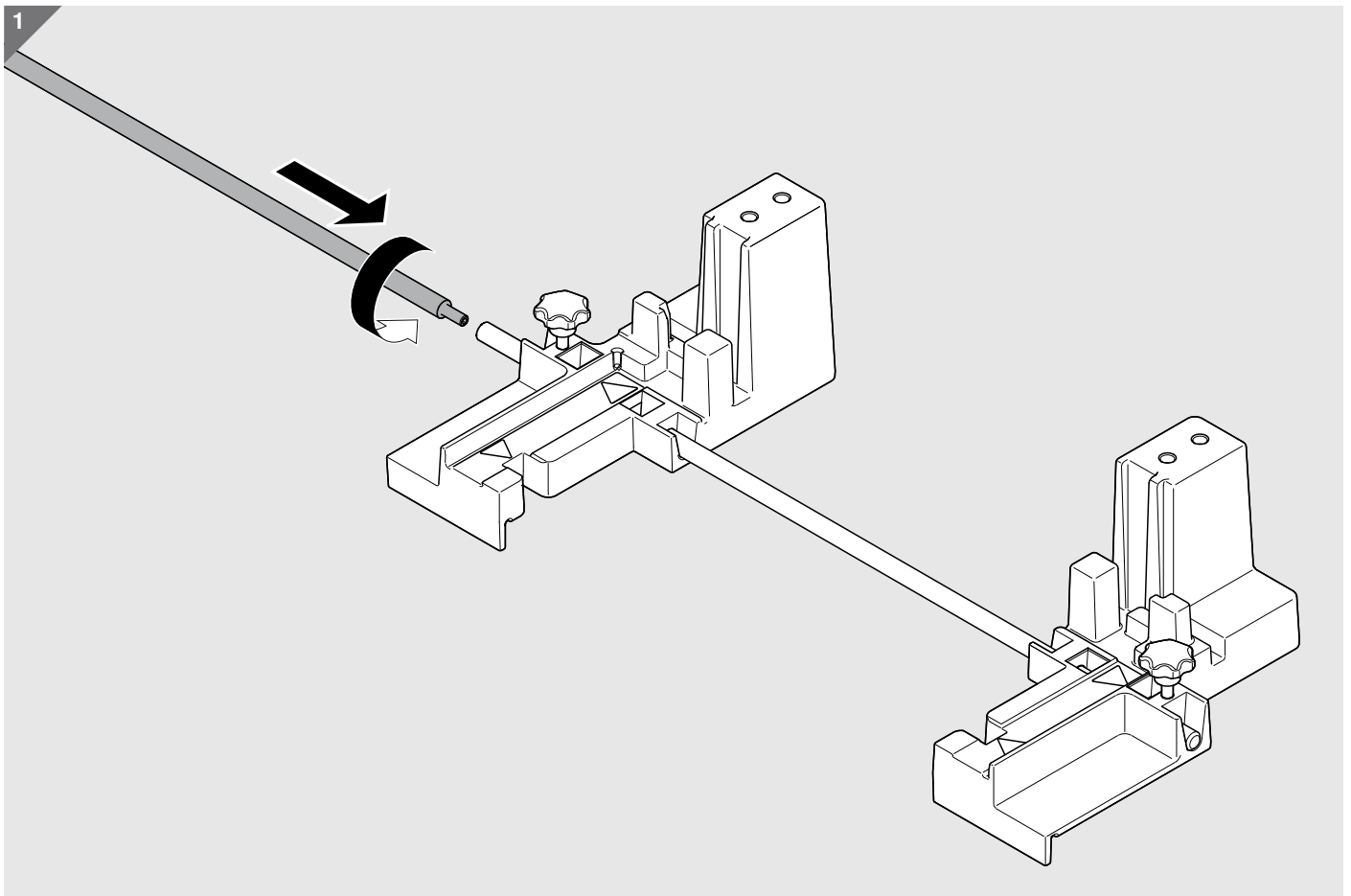

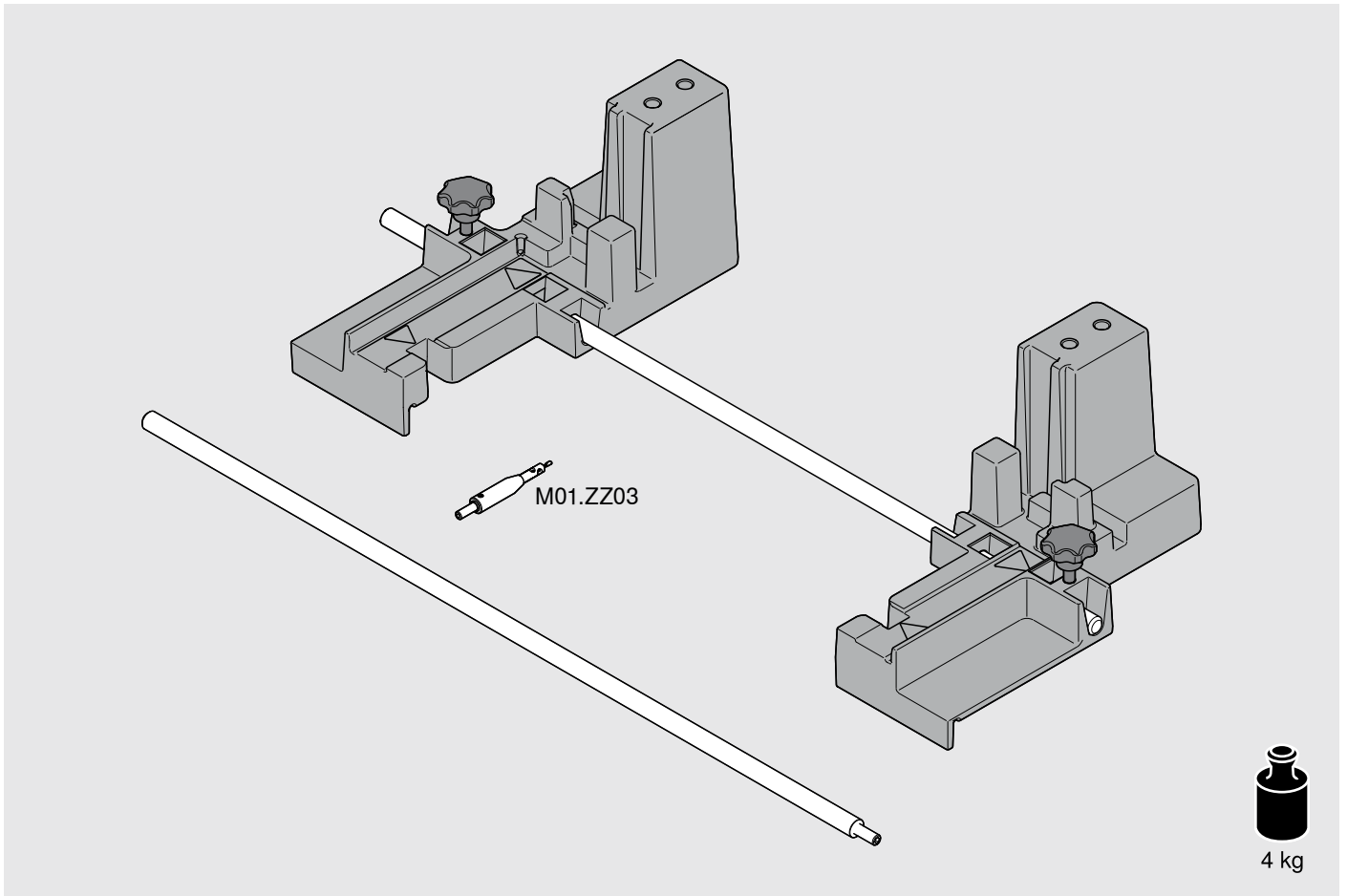
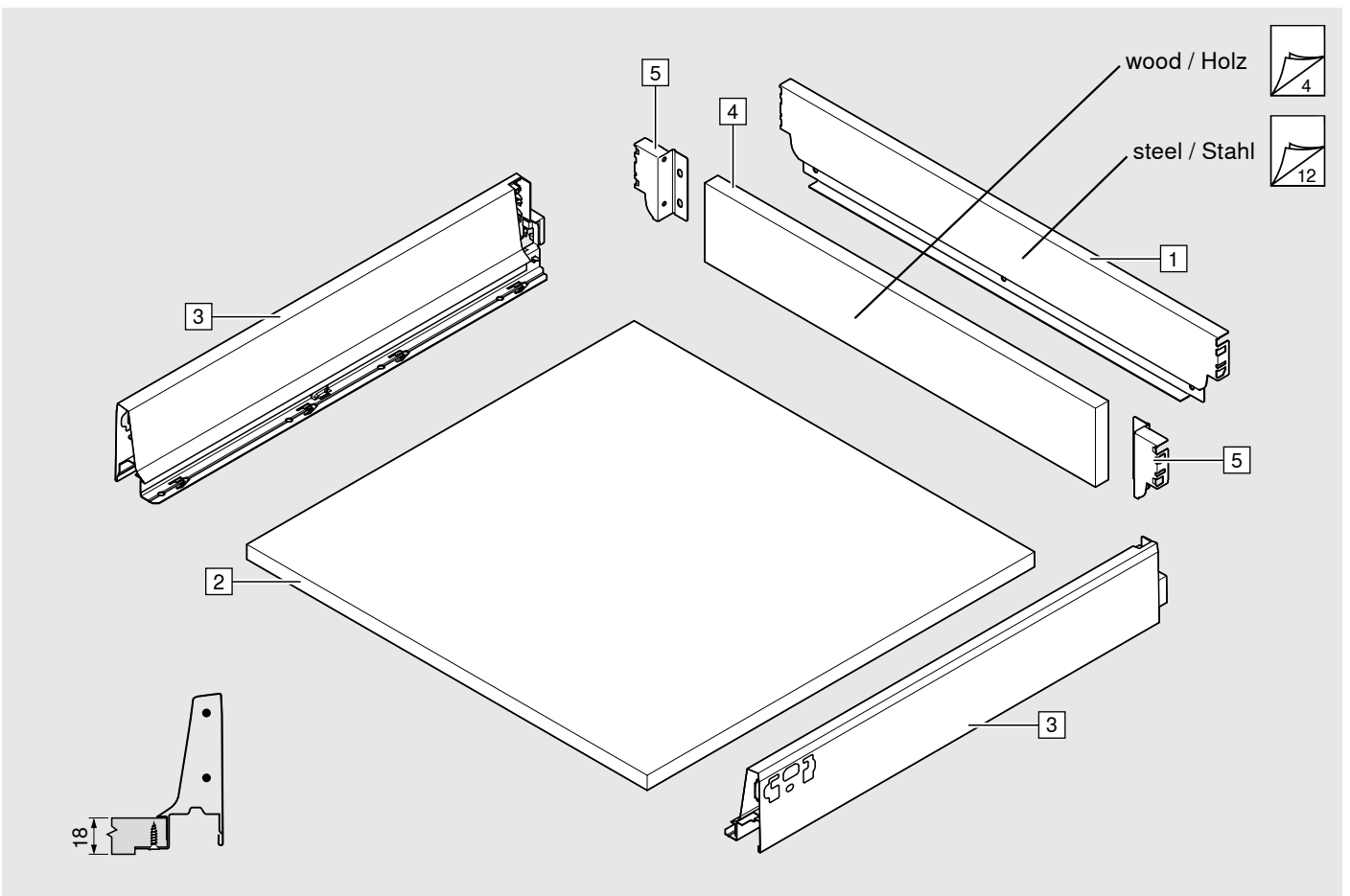
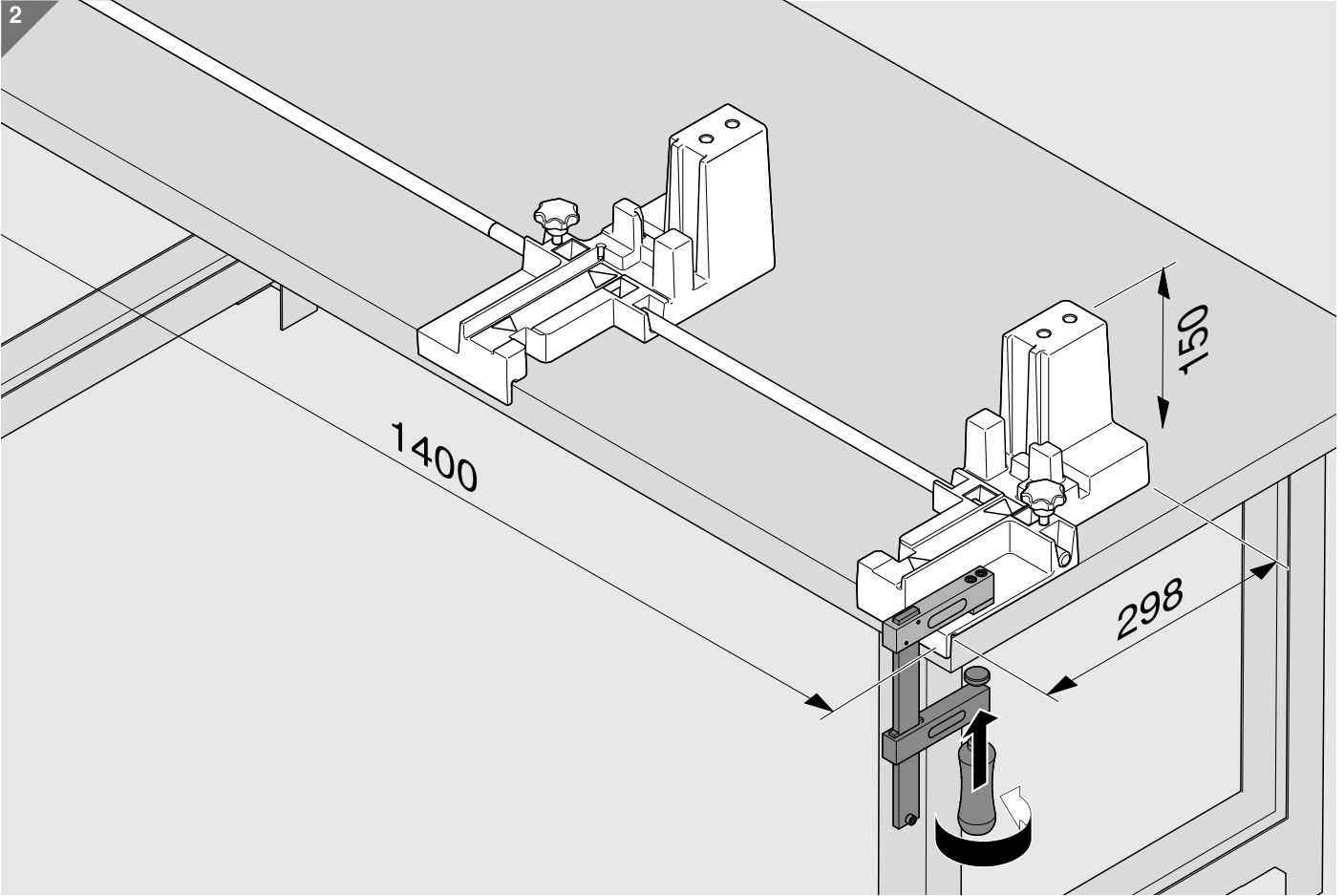

3

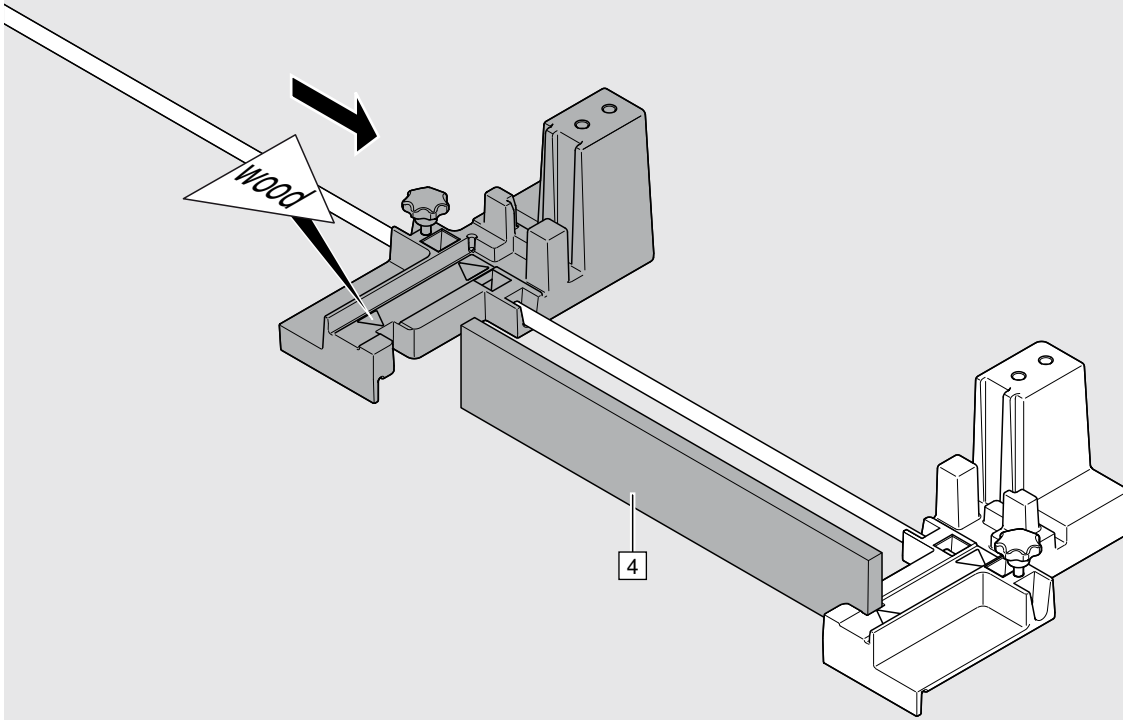

4

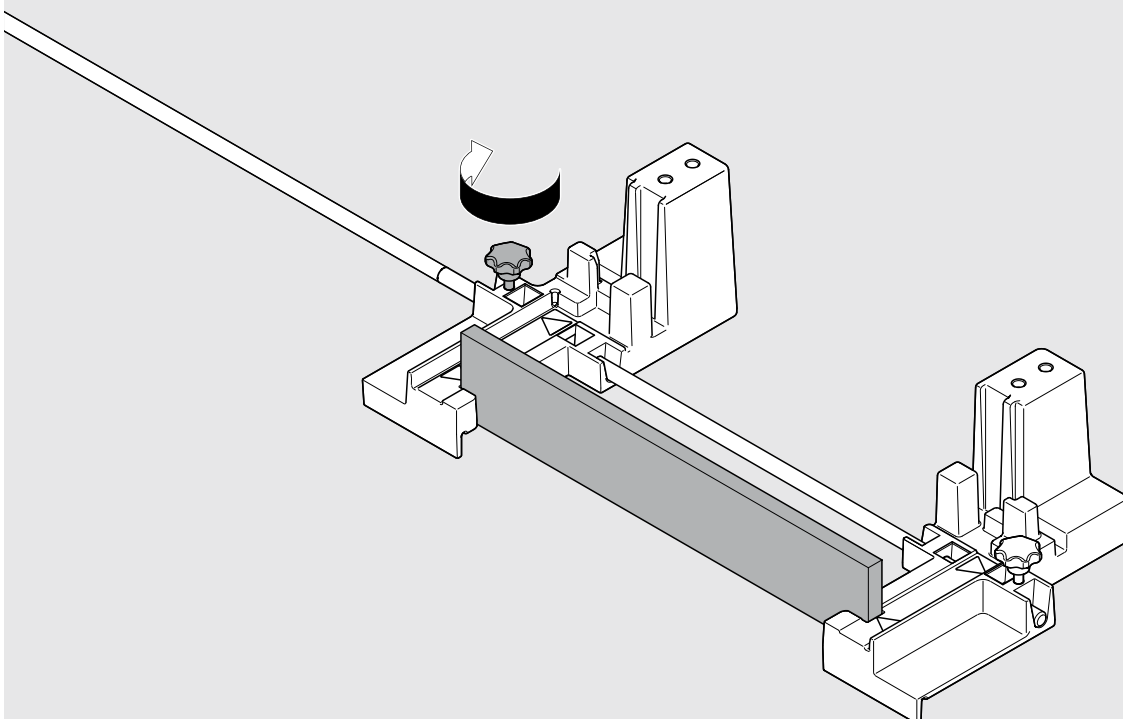

5

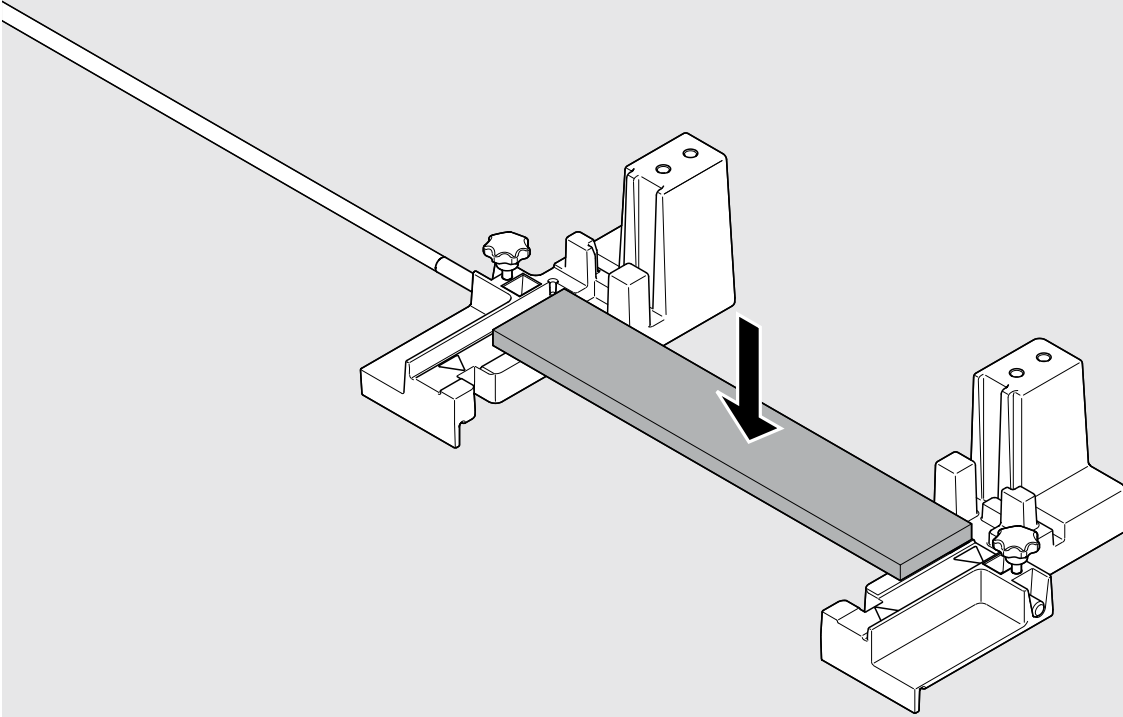

6

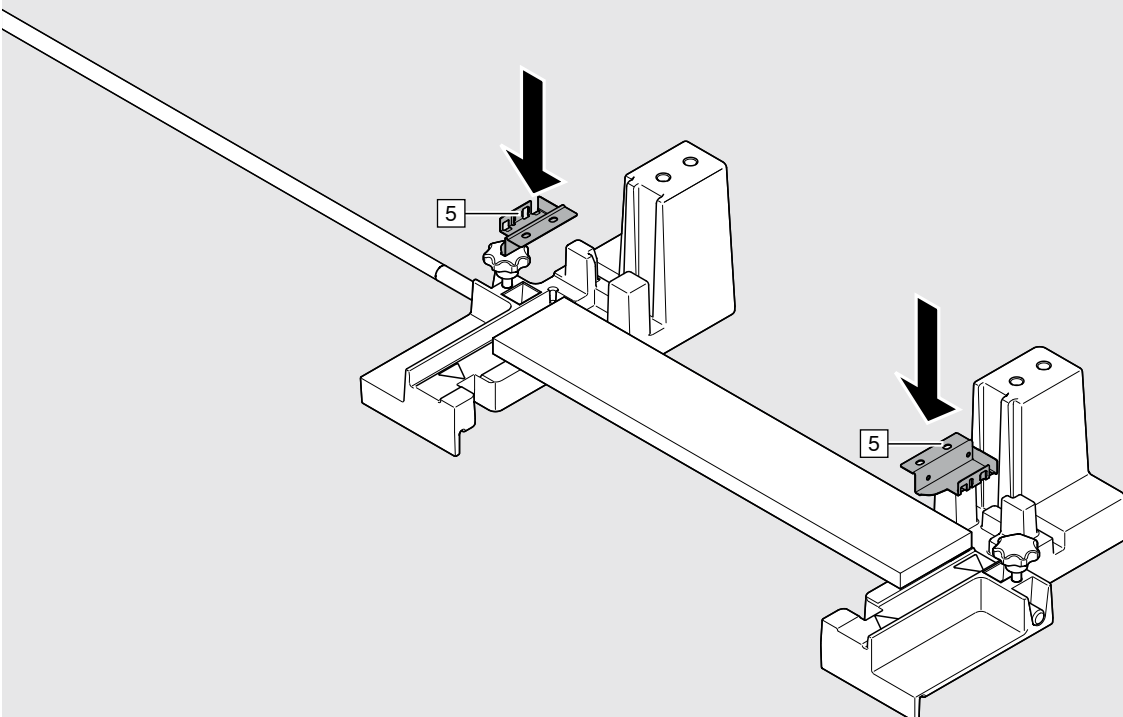

7

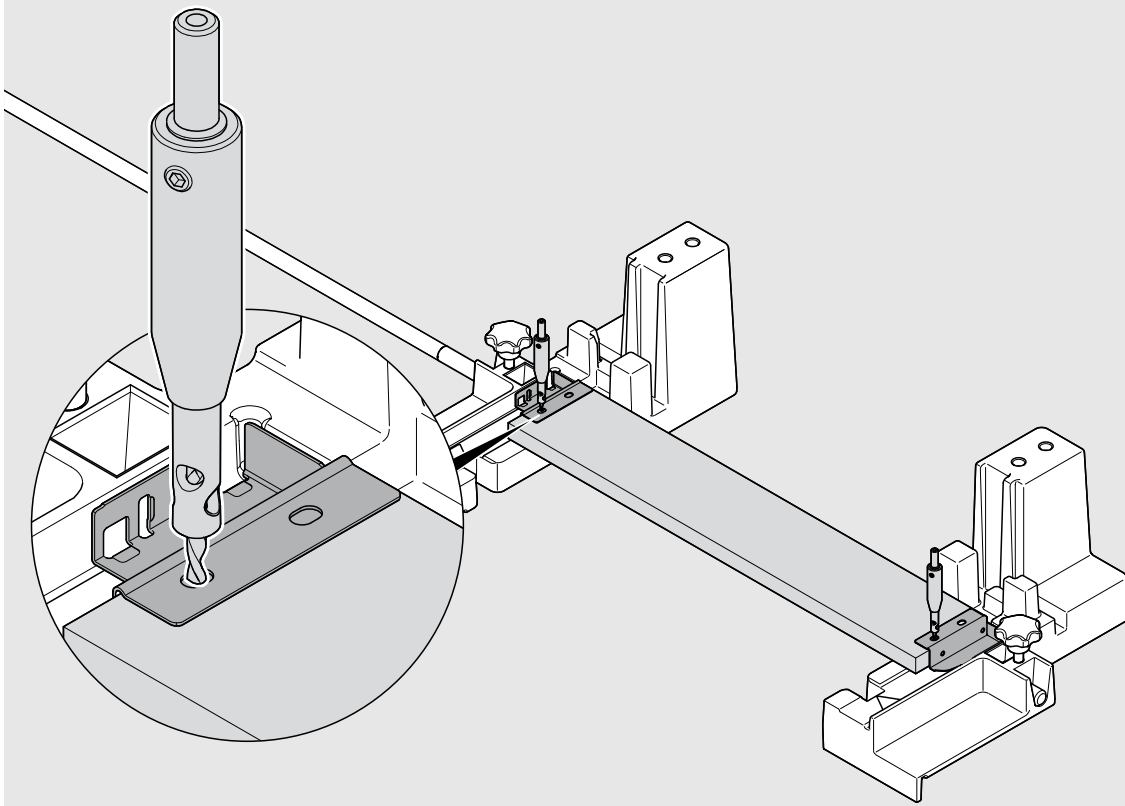

8

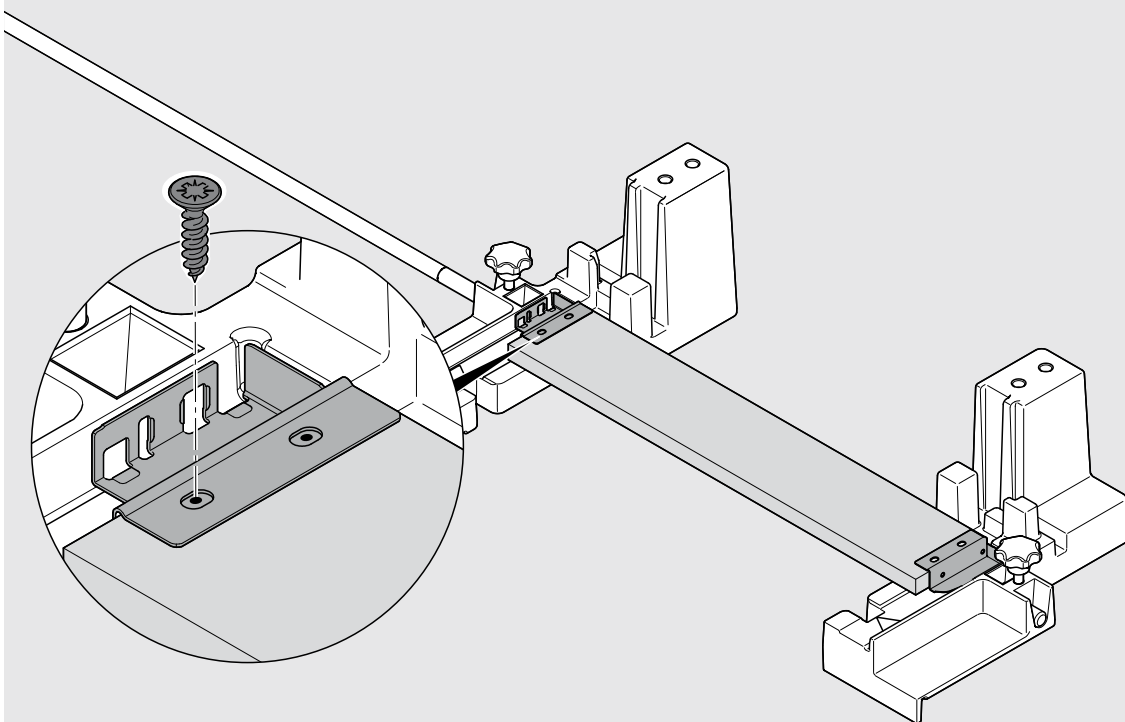

9

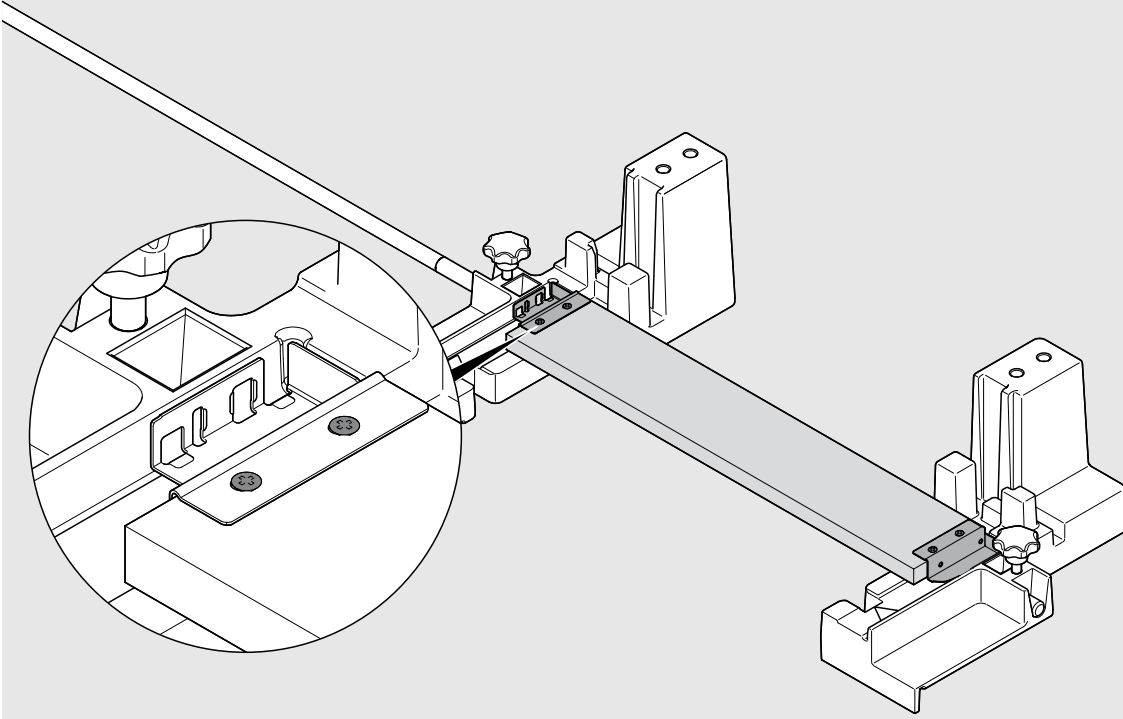

10

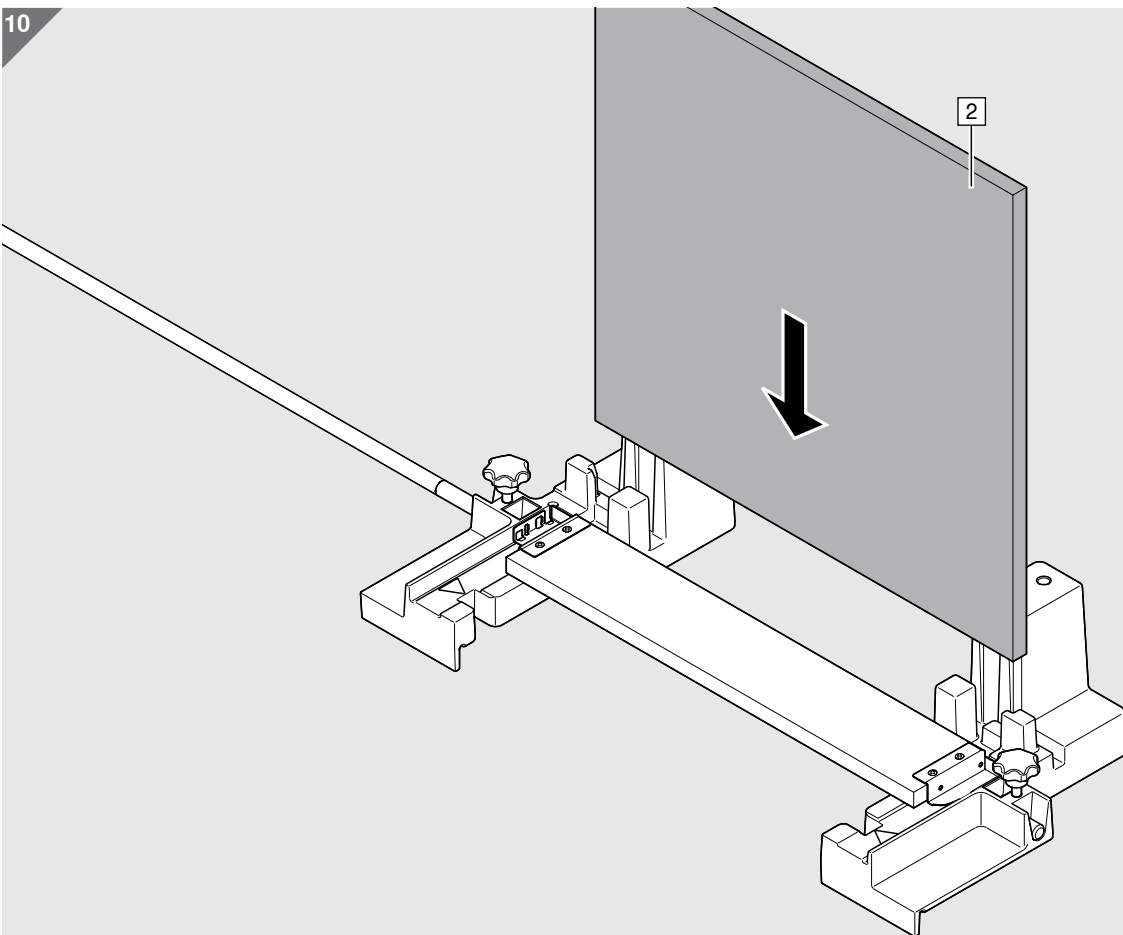

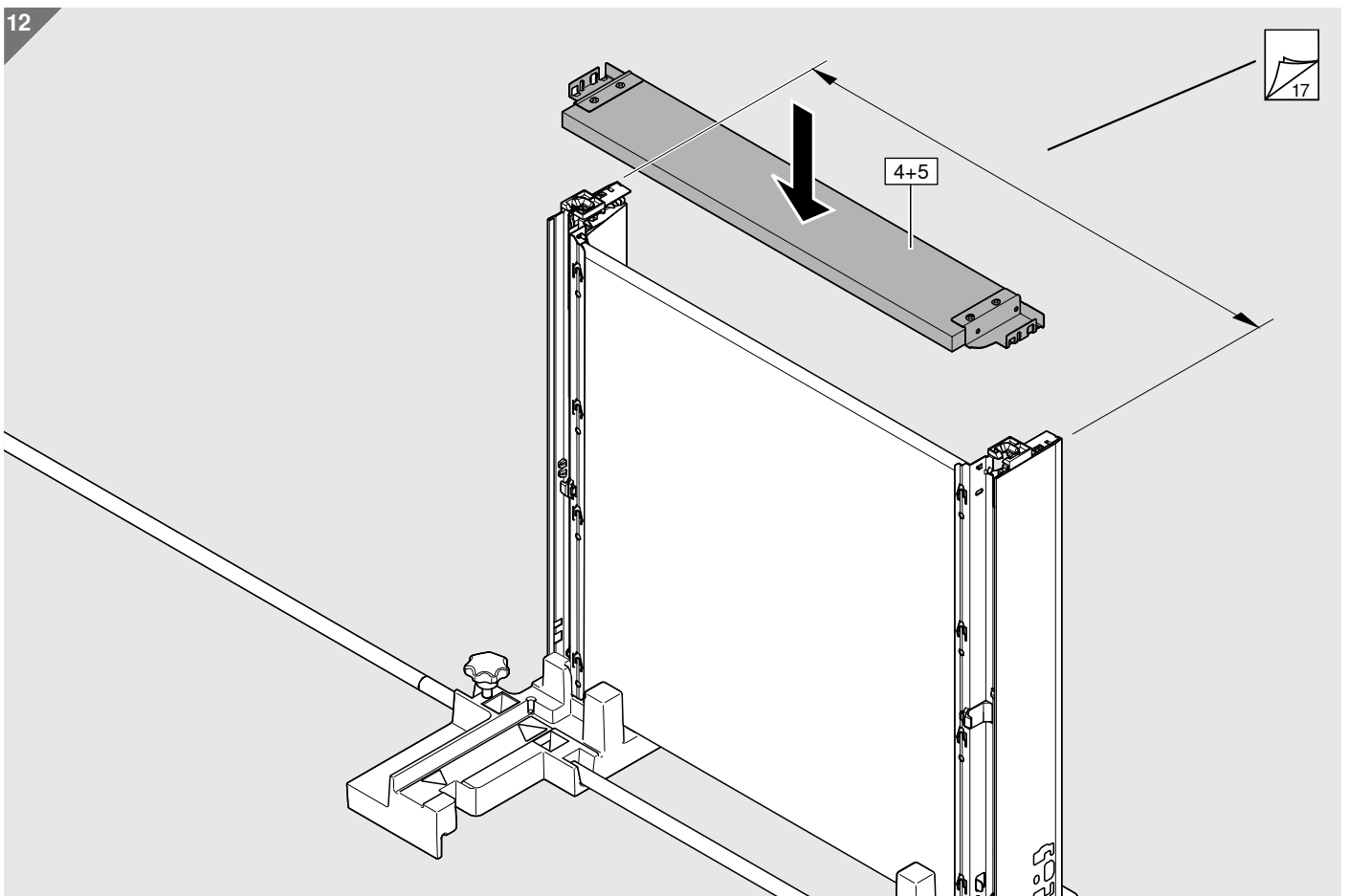
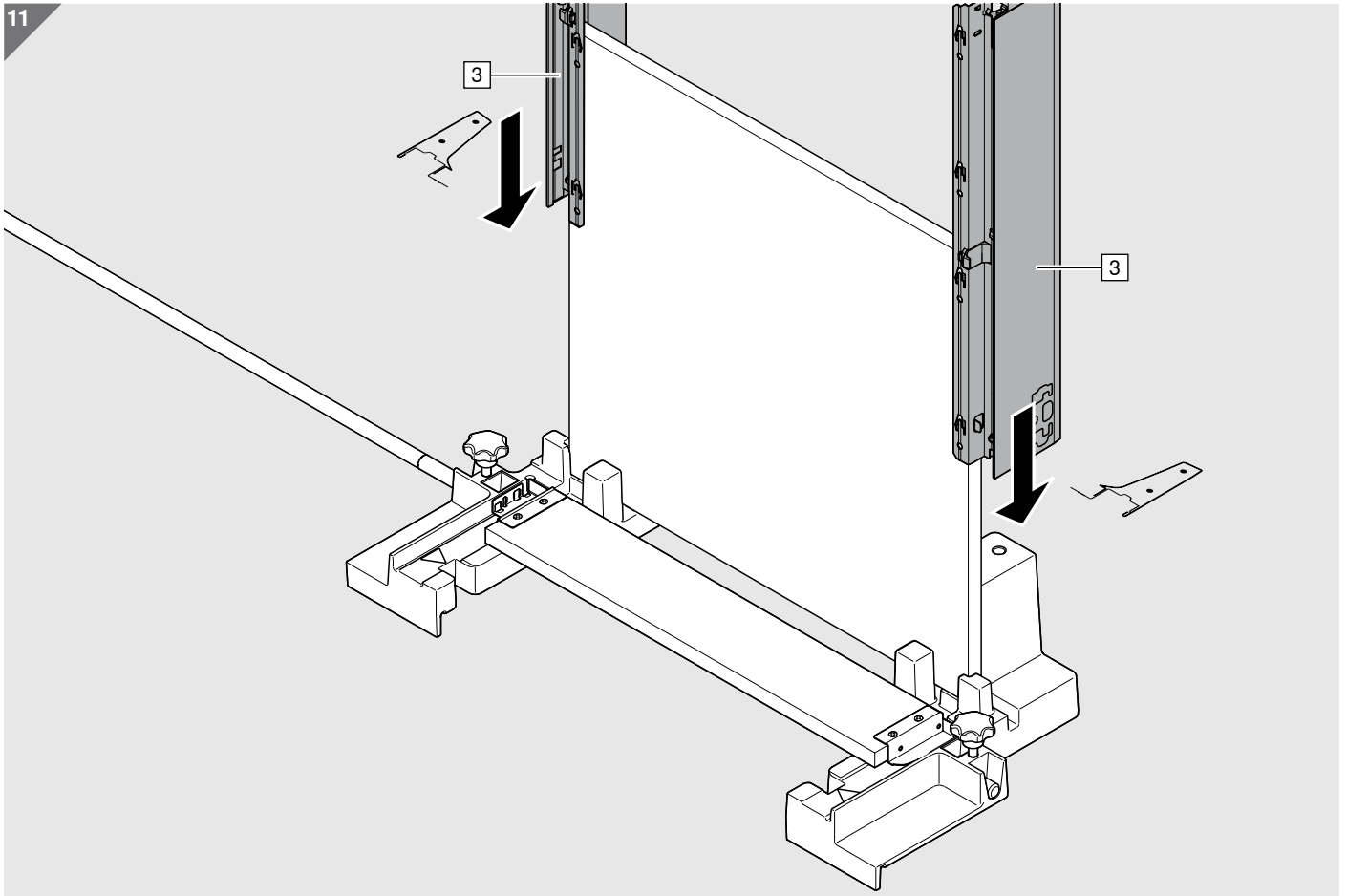

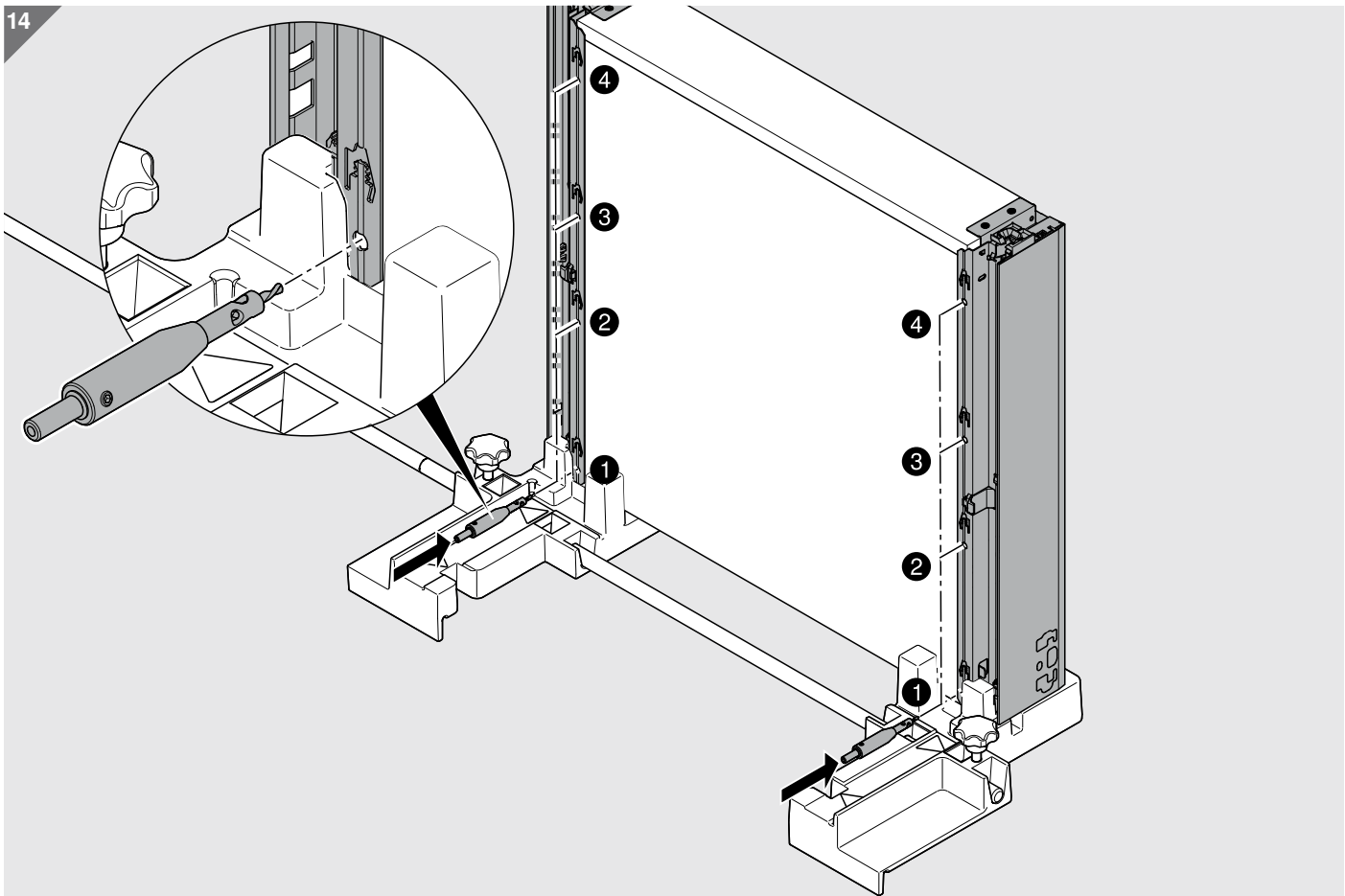
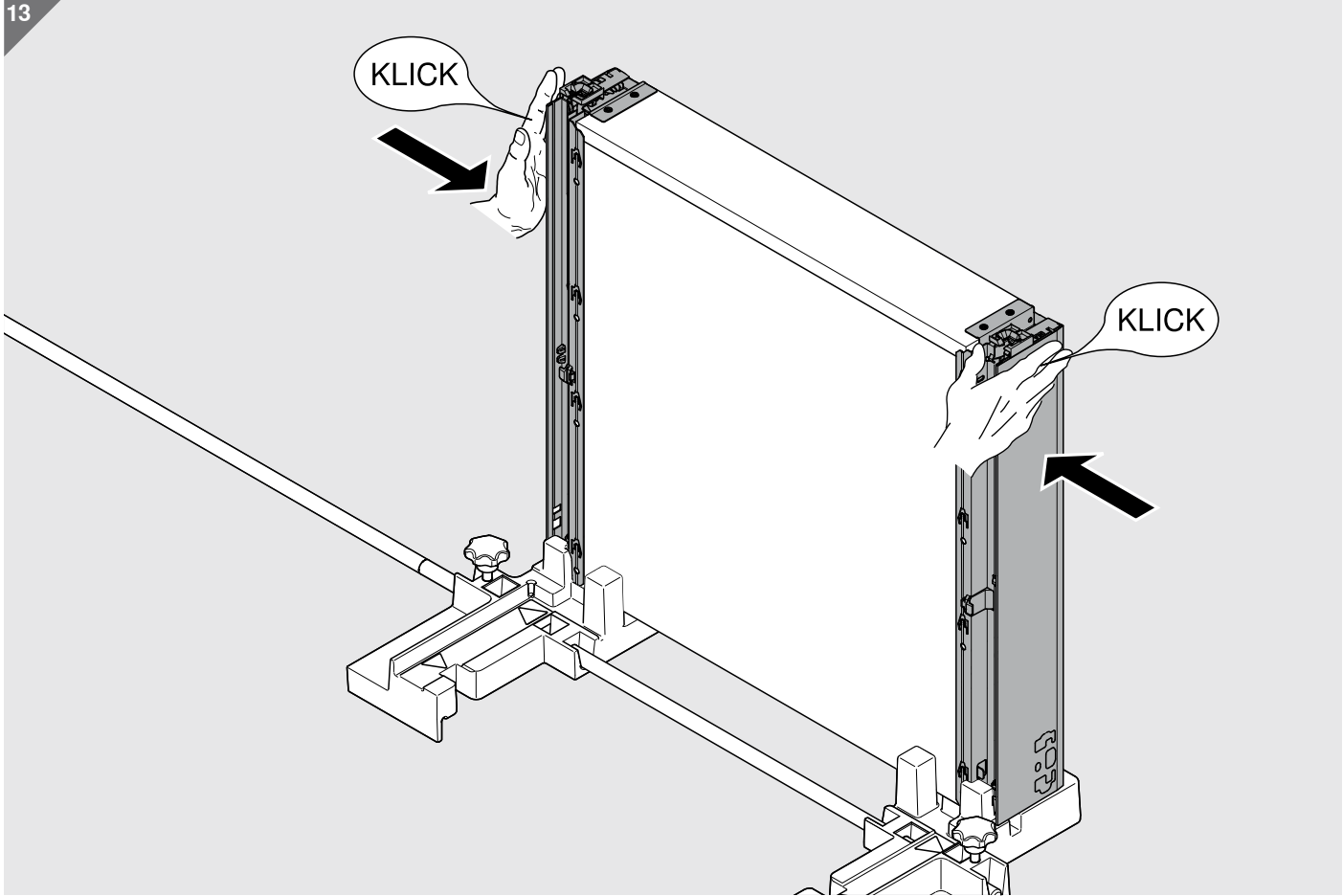

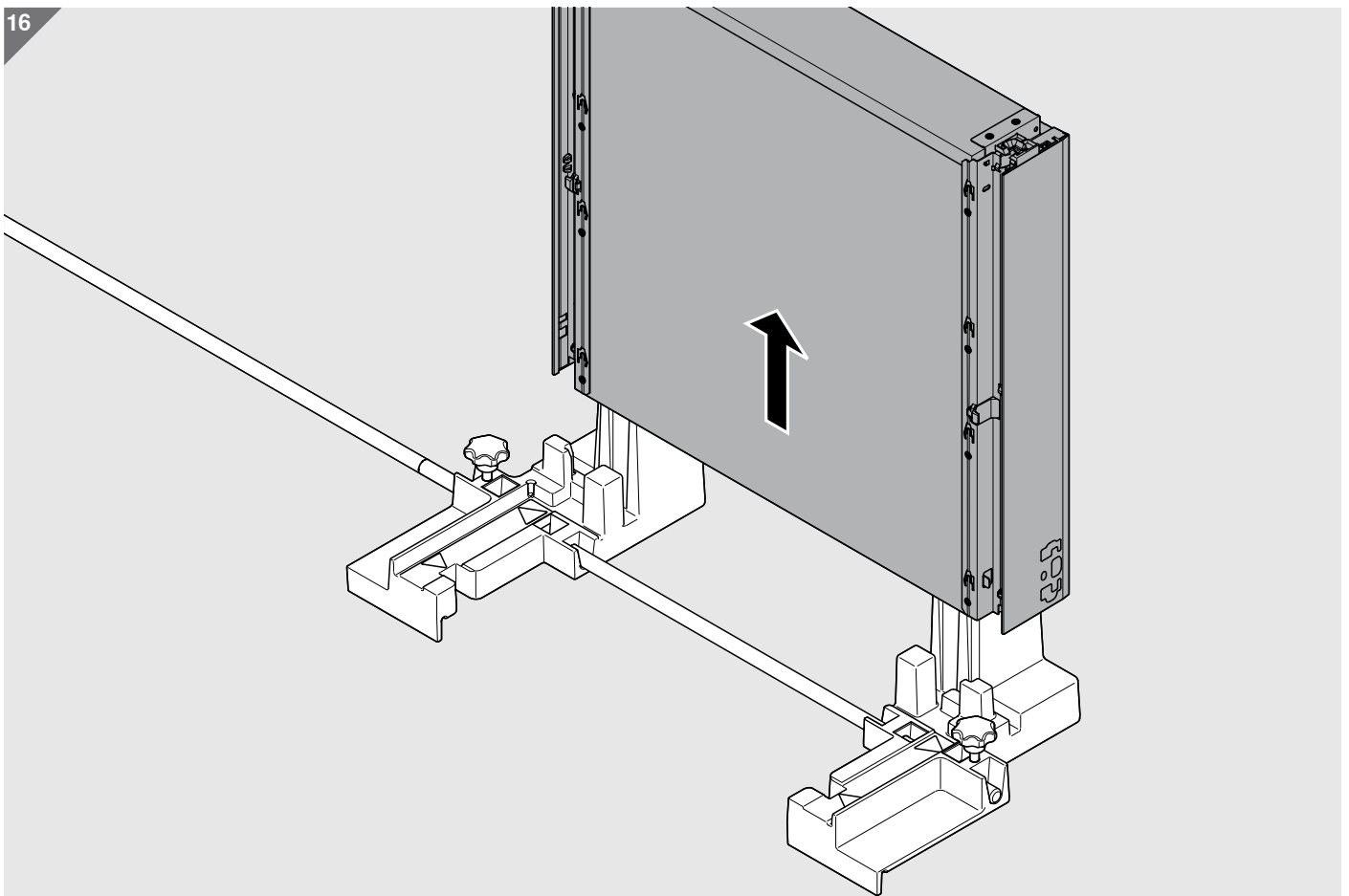
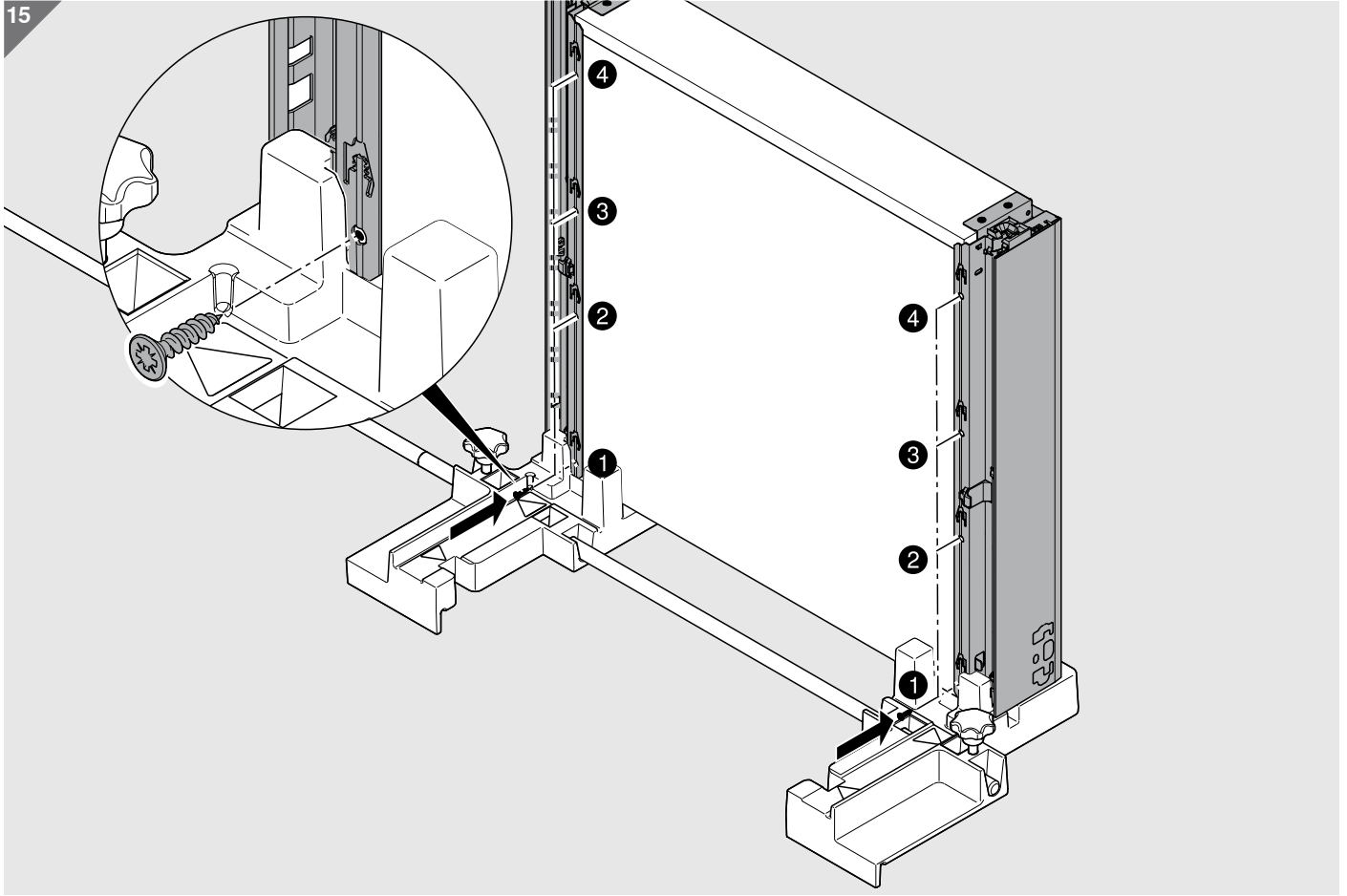

17

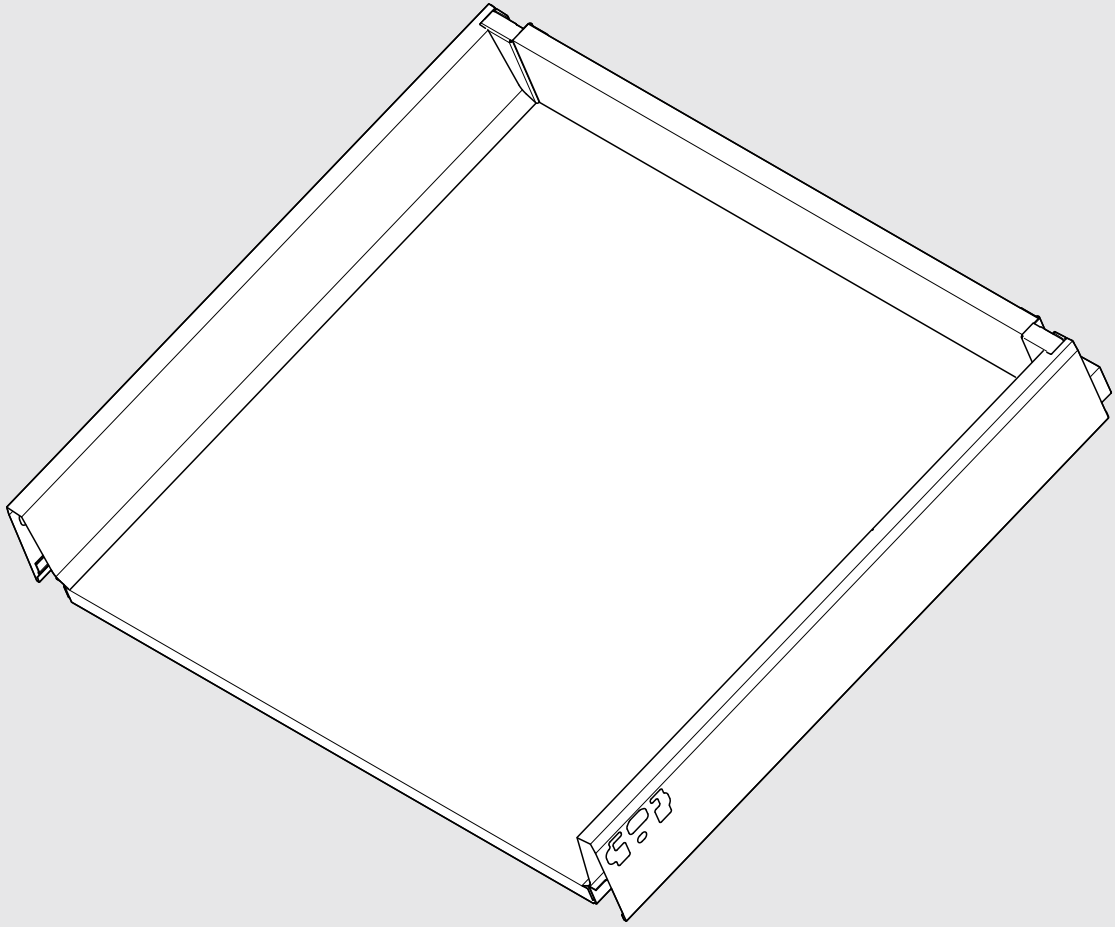

1

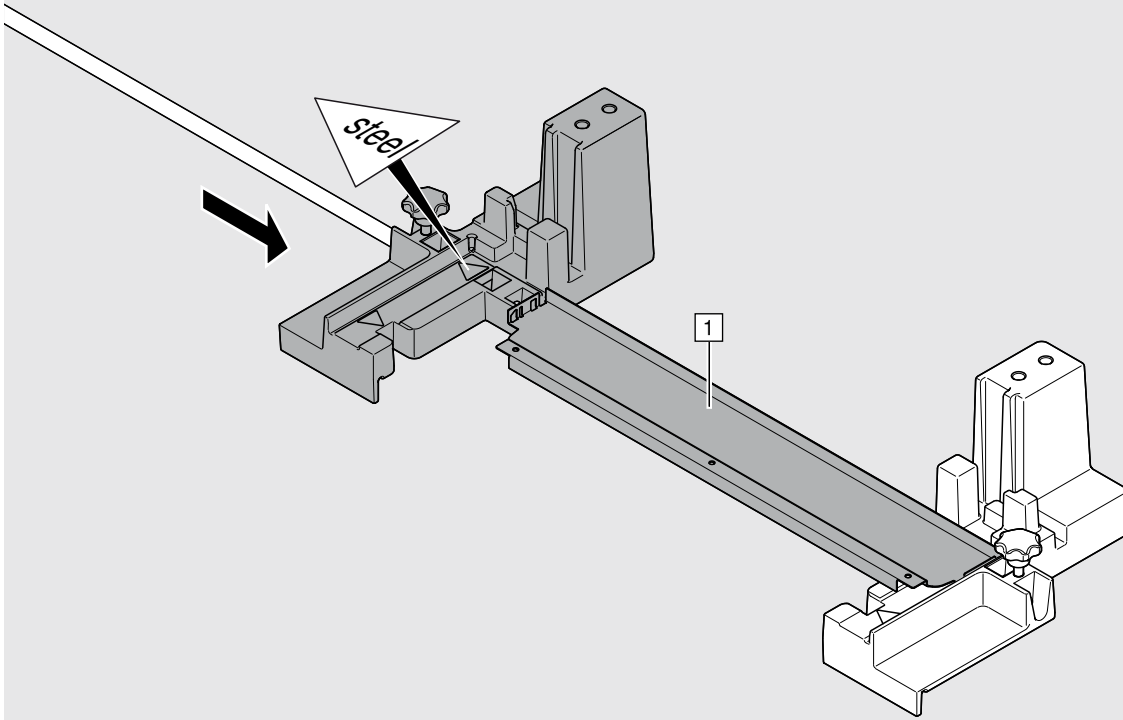

2

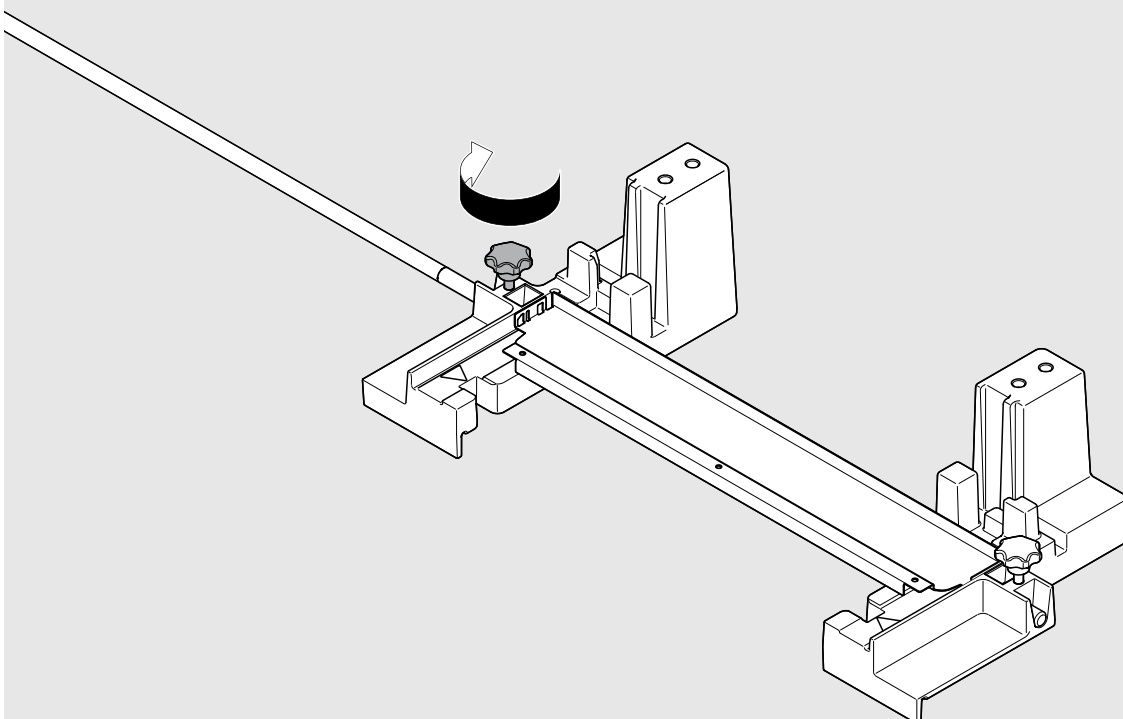

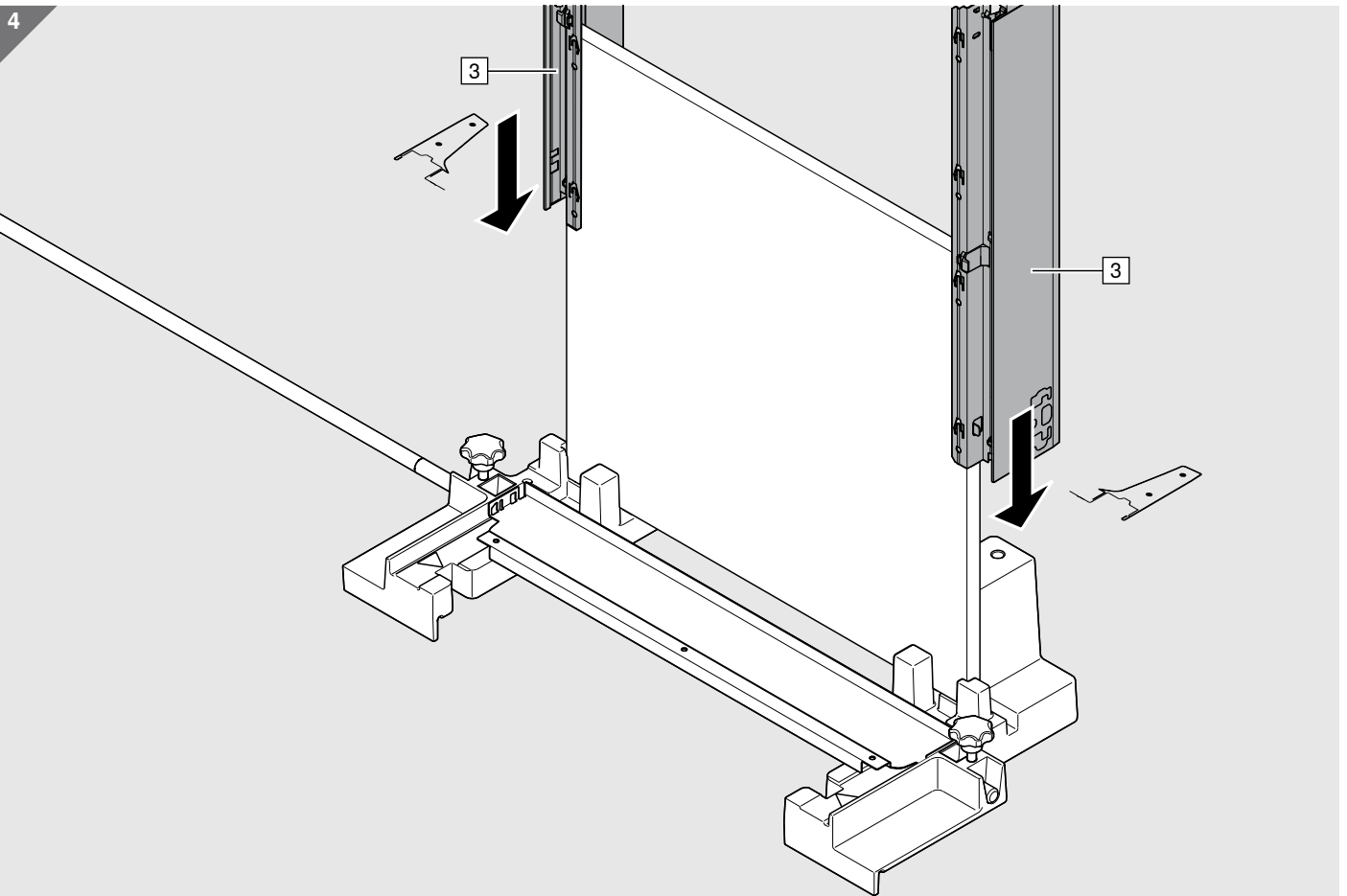
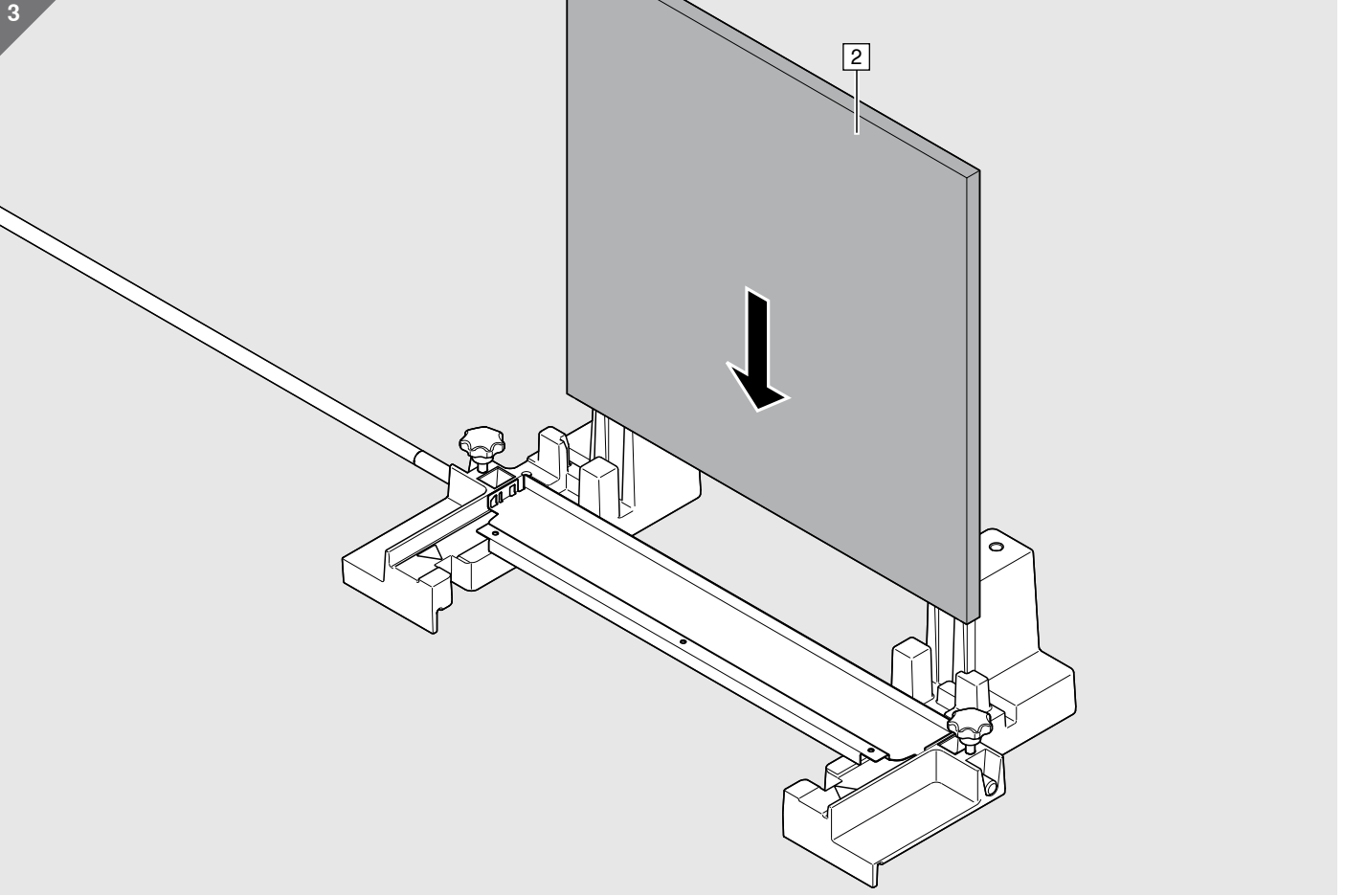

5

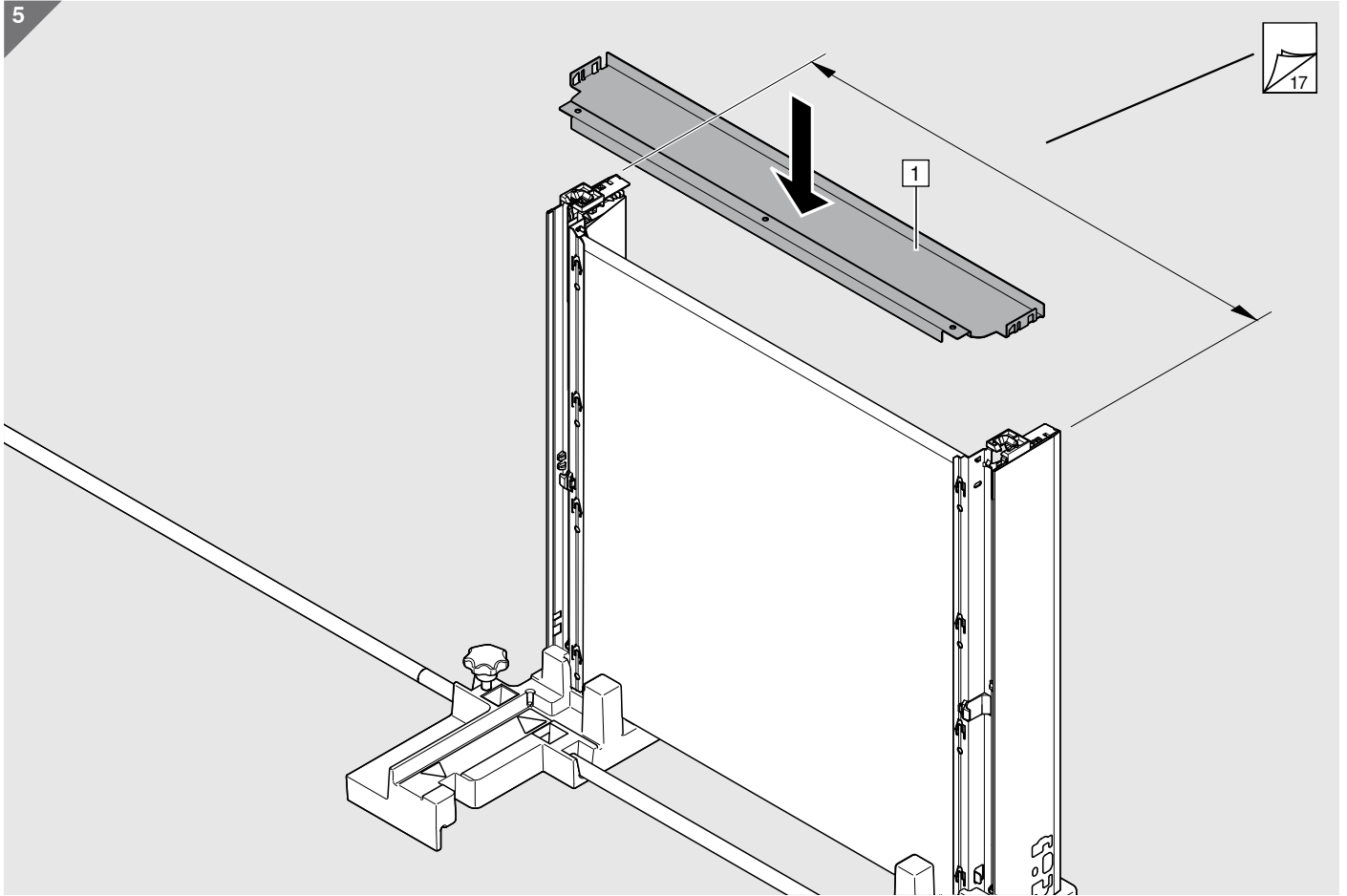

6

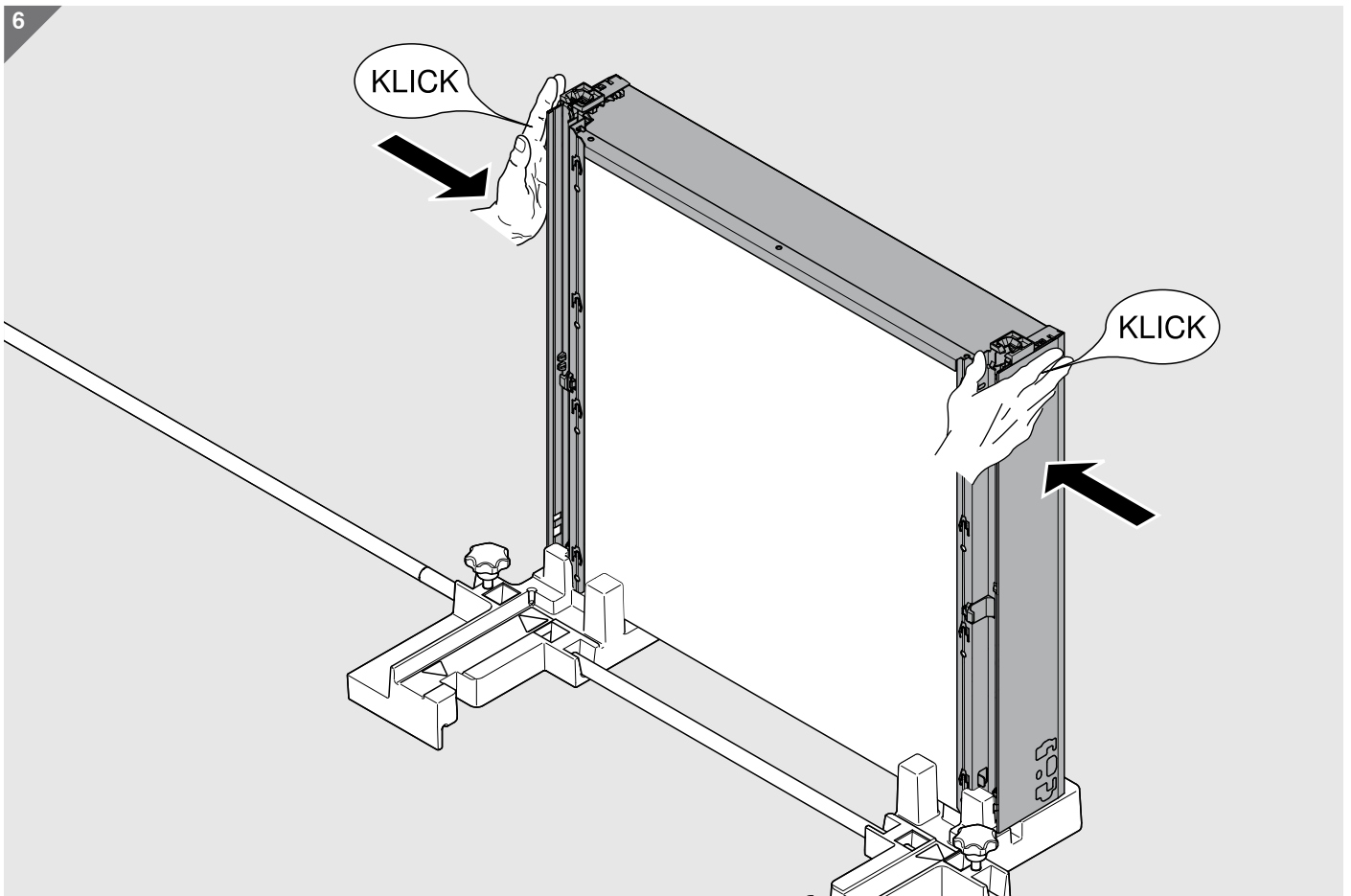

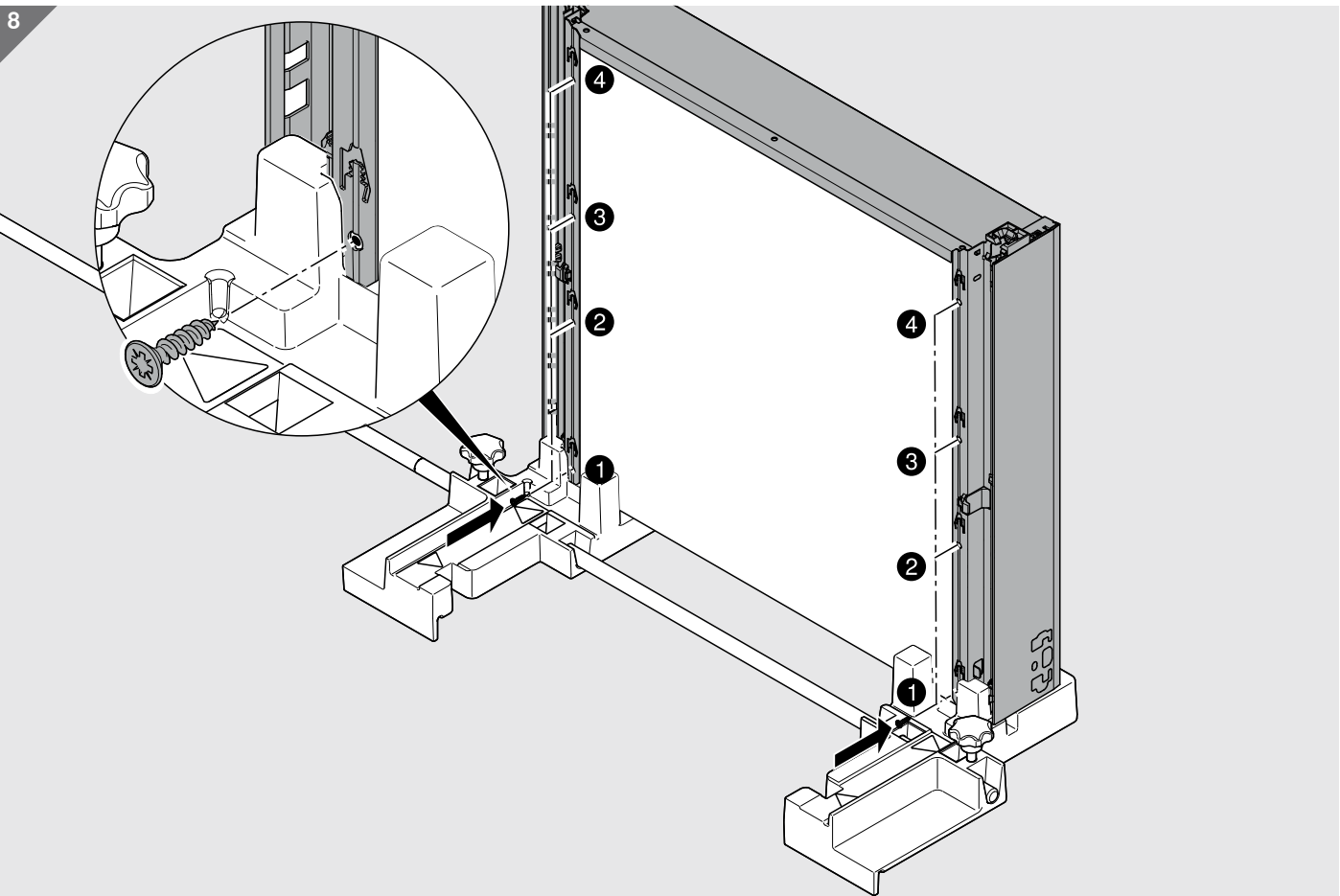
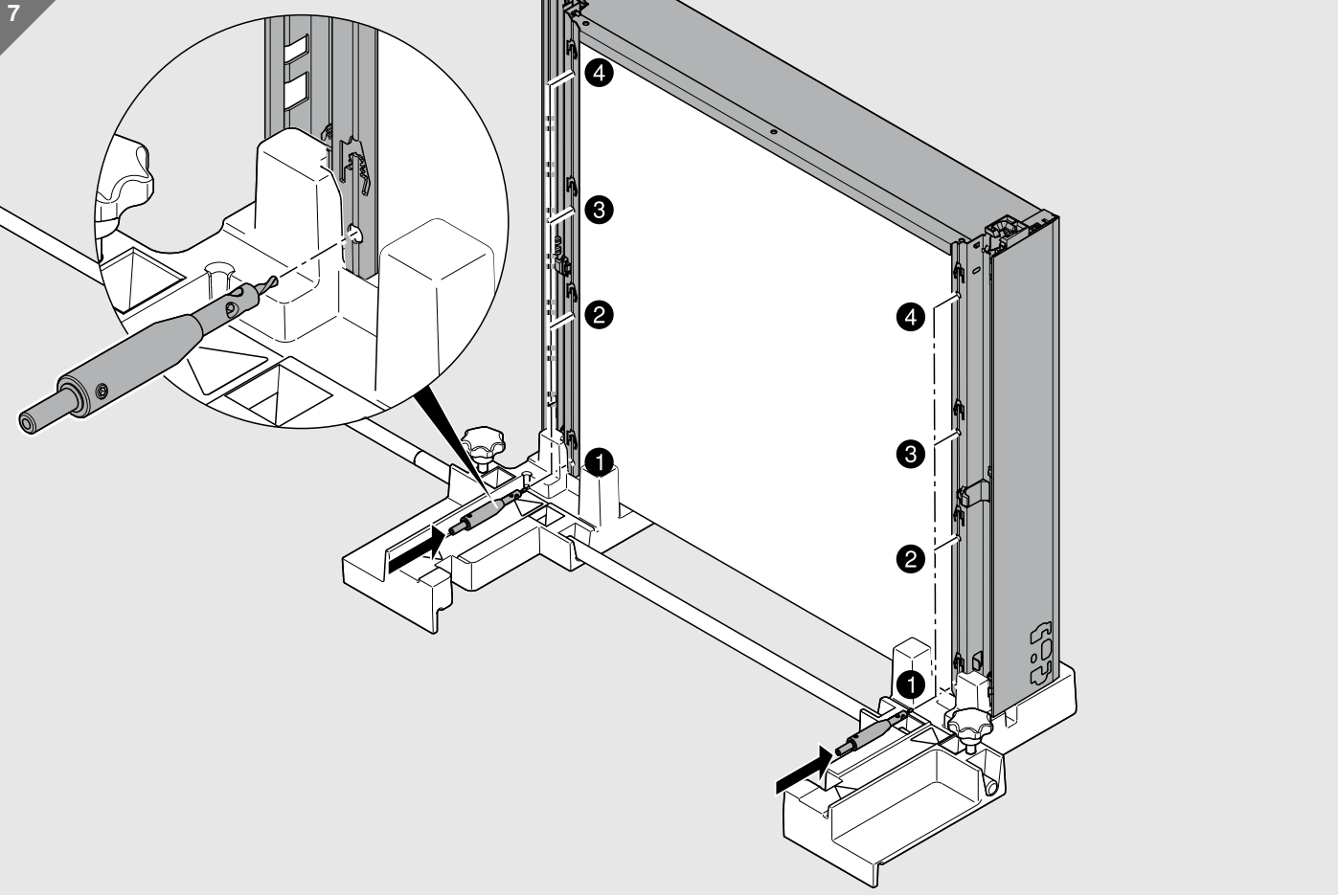

9

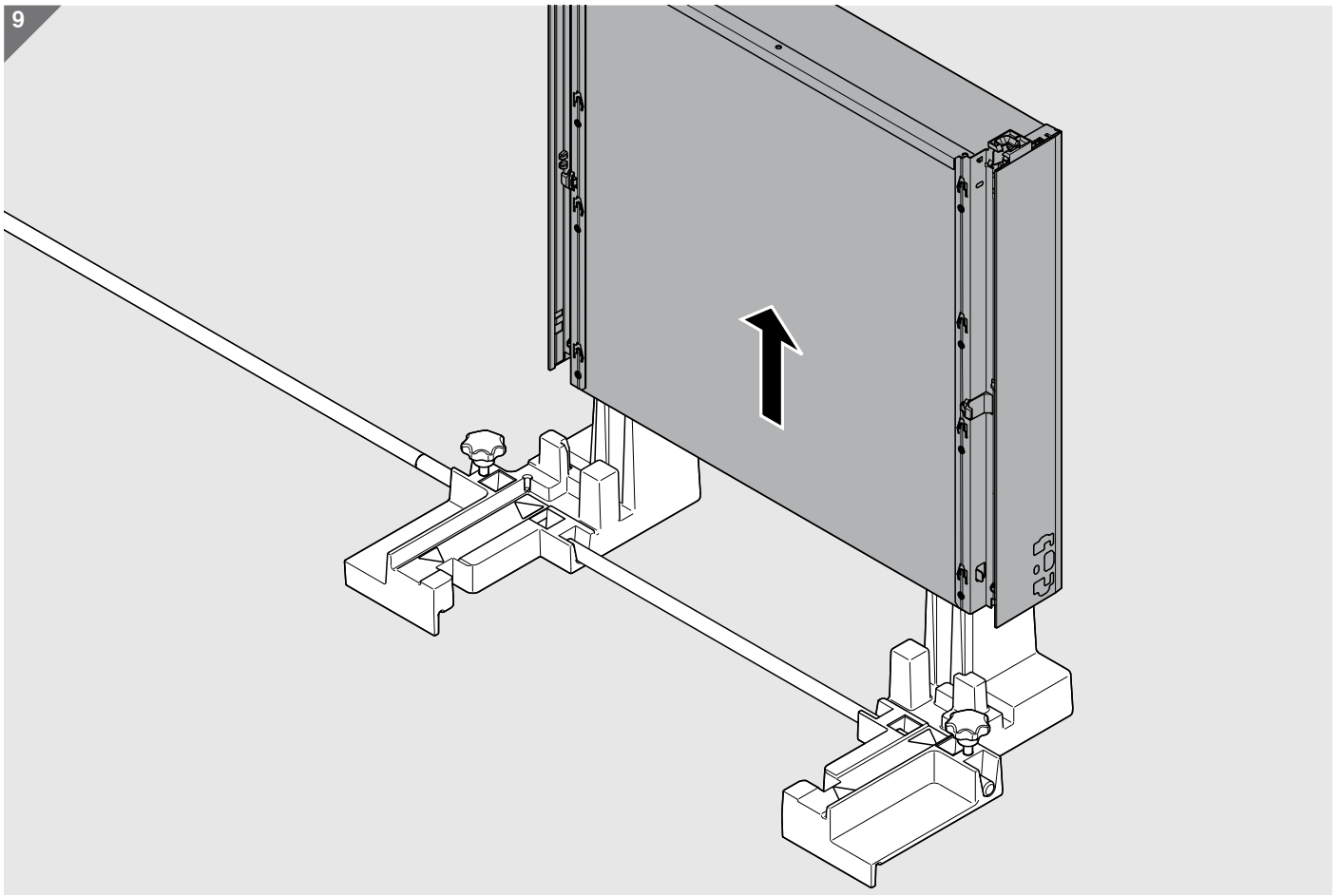

10

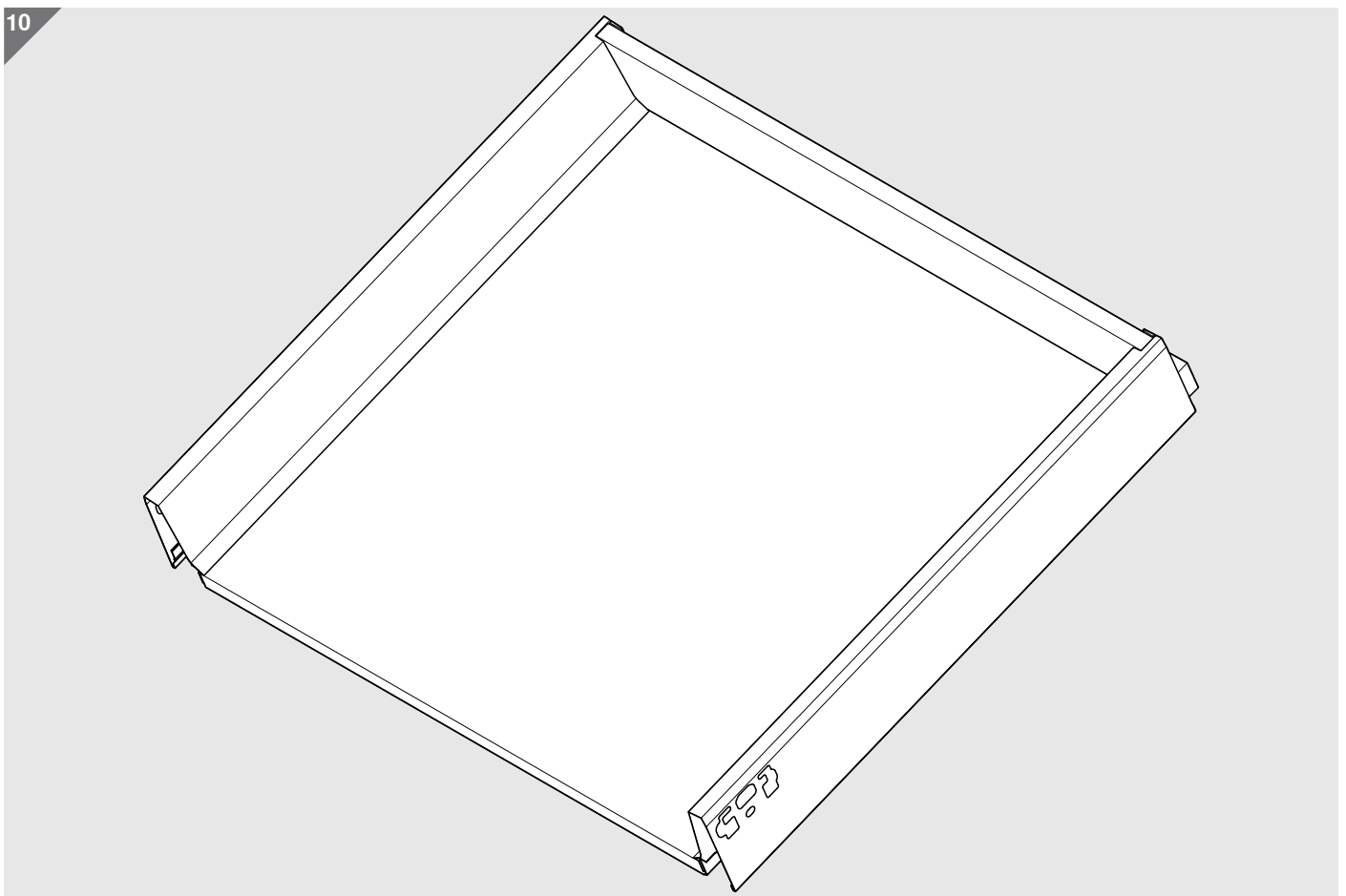

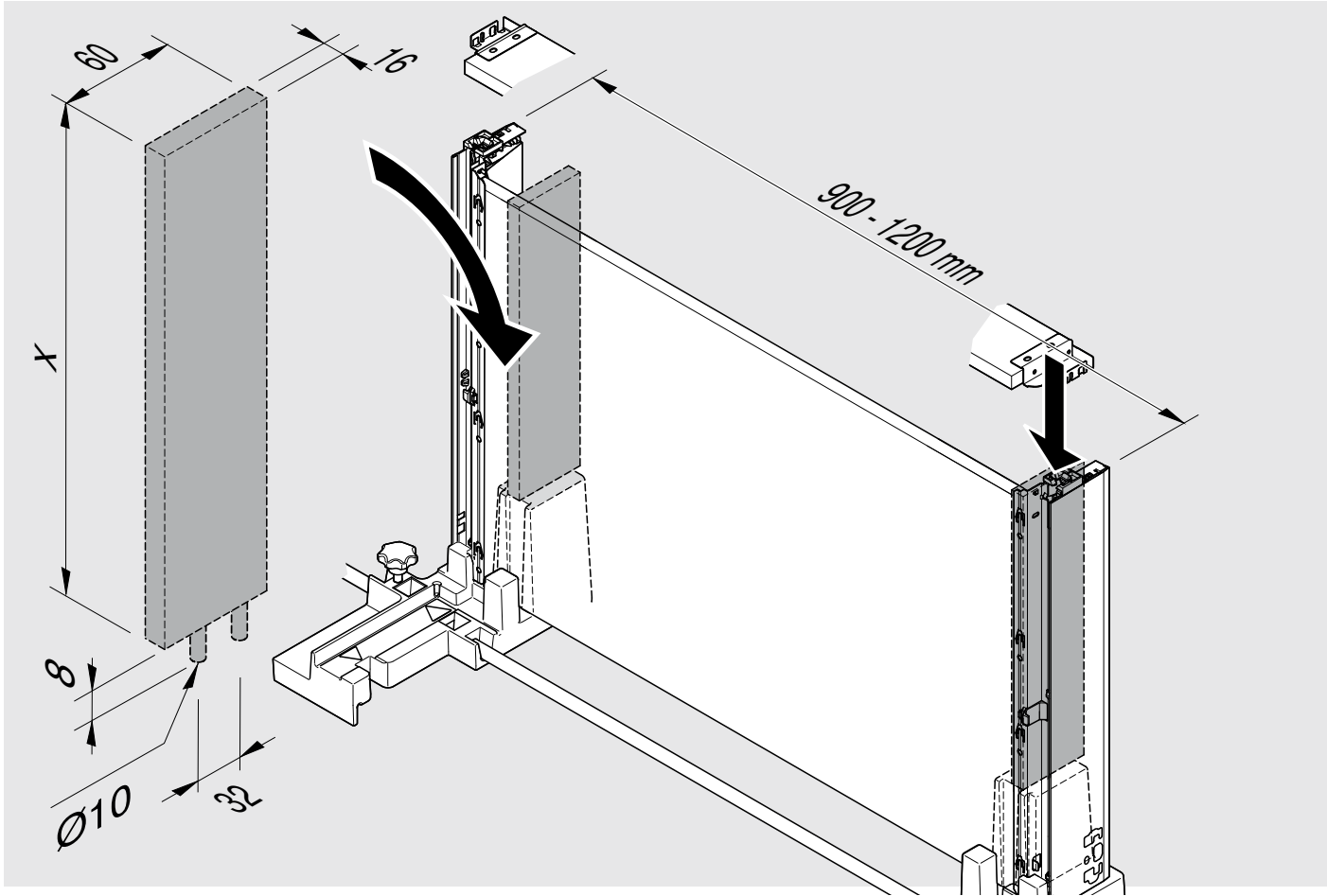

Julius Blum GmbH
Beschlägefabrik
6973 Höchst, Austria
Tel.: +43 5578 705-0
Fax: +43 5578 705-44
E-Mail: info@blum.com
www.blum.com

