



# TANDEM plus BLUMOTION

with locking device feature

Perfecting motion  **blum**®

# TANDEM: The system with variety





Simple and secure fixing system as well as increased product safety with the TANDEM locking device feature

### **Inspire your customers with variety and comfort.**

TANDEM is the ideal solution from Blum for wooden drawers and pull-outs. This concealed runner technology will enable you to produce furniture that will meet your customer's highest expectations. Due to its versatility, it provides many different options for making functional as well as beautiful wooden furniture.

Quality features such as the TANDEM ultra light running action and the new BLUMOTION, which as an option can be integrated into the runner system, provide you with perfect motion for your furniture – quiet and easy.

In the following pages, we are delighted to present you with some information regarding TANDEM's main features:

- **Application examples from different areas of furniture construction**
- **The perfect movement, quiet and easy – via the new generation of BLUMOTION integrated into the TANDEM plus full extension (TANDEM plus BLUMOTION) and TANDEM single extension (TANDEM BLUMOTION)**
- **Highest quality through ultra light running action, high load bearing and improved ergonomics using the full extension**
- **Tool free front tilt and height adjustment as well as a lift-off fitting**
- **Ordering and assembly information that is easy to understand**

# Improved ergonomics and increased storage space in the kitchen



## The advantages of the TANDEM runner system

Your customers will be able to make optimum use of their storage space with the TANDEM plus full extension. This makes working in the kitchen more ergonomic and thus more pleasant.

Your customers will enjoy the experience of using their kitchens, like never before, due to ultra light running action and the noticeably smoother movement with which pull-outs close. In addition, the BLUMOTION closing effect provides improved comfort for heavy loads. The ORGA-LINE dividing system provides optimal storage for many different kinds of items. The ORGA-LINE components are easily installed into the drawer & feature dishwasher safe removable compartments, for easy cleaning.

The TANDEM runner system also offers additional assembly advantages: The gaps of furniture fronts can be aligned precisely by hand offering many different adjustment options - no tools required. Special assembly devices and jigs provide additional assembly support.

## Optimal kitchen planning

 **DYNAMIC SPACE**<sup>®</sup> The focus of DYNAMIC SPACE

by Blum

is to provide incre-

ased comfort to the kitchen user. For more information on how to improve planning through the optimal allocation of five kitchen zones, how to determine your storage space needs as well as many other practical tips and hints, please go to:

[www.dynamicspace.com](http://www.dynamicspace.com)



## Perfect storage space organisation using ORGA-LINE

Using the ORGA-LINE divider system, you can individually design the interior of drawers and pull-outs. High quality stainless steel and durable nylon components are utilised to give lateral and cross division of the drawer. The system provides perfect organisation & easy access for all drawers & pull-outs.

Natural wood can be used to produce unique, high quality drawers. The ORGA-LINE cutlery & utensil division system incorporates a sprung section to allow for a variety of internal drawer depths. Blum also offers the right organisational options for high fronted pull-outs with lateral gallery rails as well as flexible cross and lateral dividers.

## More organisation in the hall



### Thousand and one little things to store

There are a number of things that need to be stored in the hall:

Keys, notebooks, sunglasses, hats, gloves, umbrellas, scarves, shoes, shoe cleaning supplies and much more.

You can offer your customers a more versatile range of hall furniture through functional and fully removable pull-out systems in addition to a well thought-out organisational system. With ORGA-LINE, the interior of drawers and pull-outs can be customised individually. The TANDEM runner is fully concealed when assembled on-to the drawer, so it does not detract from visual impact of the wood, and provides a high quality finish to the furniture in the hall.

## Better design in the living room



### Wider pull-outs as a design feature style

Wide pull-outs used in the living room can be a bold style statement. Easy access to, and clear organisation of the drawer contents compliment this relaxing area of the home – the ideal location for using the TANDEM runner system.

Wide pull-out elements make increased demands on the performance of the runners in terms of side stability, load bearing and minimising sagging.

In addition, minimum gaps demand an exact closing position and front setting options. TANDEM runner systems provide outstanding support for all of this.

## More ideas for the bathroom



### **A bathroom needs creativity**

The manufacture of bathroom furniture is often difficult, working within the constraints of limited space & individual requirements. Different kinds of items used within the bathroom demand creative solutions from equipment & design.

TANDEM runner systems are an optimal solution in this area. They provide numerous application options thanks to nominal lengths of 250 to 750 mm.

### **Different items can be optimally stored**

Lots of items need to be stored in a bathroom such as skin care products, accessories, towels, cleaning and washing products, etc. Many are used daily and need to be close at hand.

The ORGA-LINE system provides a customised place for each and every one of them. Thanks to the TANDEM full extension, you have access even into the farthest corner. Cosmetics, perfumes and other high value personal care products are kept safe and secure with the ultra light BLUMOTION closing action.



## More comfort in the bedroom



### Cabinets with intelligent fittings

Opening a large cabinet front can reveal a variety of storage options to keep all your clothing in a clear and easily accessible manner. TANDEM pull-outs enable many different furniture design options, e.g. inner drawers and inner pull-outs which disappear elegantly behind closed doors.

BLUMOTION provides quiet and easy closing movements to ensure peace and quiet during daily use.



# BLUMOTION: Perfect movement, silent and effortless

Now it is even easier to implement BLUMOTION in furniture manufacturing: With the next generation of TANDEM runners, BLUMOTION is now integrated and thus protected.



This makes not only ordering, but also transport and assembly much easier than ever before. A function for special pieces of furniture that creates added value and wins over your customers.



## Adaptive system – more than just dampening

This next generation of BLUMOTION reduces the forces involved in closing drawers and pull-outs to provide a quiet and easy closing movement.

This unique effect is achieved by a diaphragm within the cylinder that reacts to the closing force that is used. Whether the pull-out is heavily laden or empty, pushed gently or with force – BLUMOTION will close it with perfect movement every time.



## The perfect closing movement: Now integrated into TANDEM plus full and single extension

**You too can benefit from our innovation for the quiet and easy operation of drawers and pull-outs.**

By combining BLUMOTION with the effortless and smooth running action of TANDEM, we have completely redefined standards in drawer movement. Let your customers be inspired. Whether used on a drawer or a fully-loaded high fronted pull-out – all applications operate perfectly every time. With just a light touch, they close silently and effortlessly.

You can now order the new TANDEM plus BLUMOTION (full extension) and TANDEM BLUMOTION (single extension) and save yourself assembly effort – because BLUMOTION is now integrated into the runner system.



# Your advantages at a glance



## TANDEM plus: The runner for ultra light action

The TANDEM runner is the innovative system for ultra light running action for pull-outs and drawers.

The roller carriage with low-friction cylindrical rollers and dampened rail transitions reduce noise and provide fluent movements - for the life of the furniture.

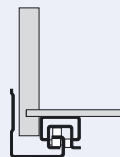

## High load bearing stands for quality

The TANDEM runner in the testing lab: Even with high loads, the technology guarantees high side stability and minimal sagging. The horizontal and vertical cushioning of forces guarantees ultra light action even when loaded. TANDEM pull-outs can be loaded with up to 30 kg. TANDEM plus full extensions have load bearing capacities of 30 and 50 kg depending on the version.



## Strong enough to support the heaviest load

Modern furniture often has wide pull-outs with high fronts. This provides more storage space but also increases the weight. For these increased loads - especially for the high fronted pull-out - TANDEM plus BLUMOTION provides a unique innovation: The new bridge block design supports the runner system over the entire length of the opening and closing action. It provides a secure and controlled closing action even when fully loaded and has a precise gap capability.



## TANDEM plus full extension

Offer your customers furniture that guarantees comfort because of its high functionality. Our full extensions enable optimal storage space utilisation and because they improve ergonomic workflows, they make your furniture something that goes beyond the ordinary.

The advantage is plain to see: The entire contents can be seen all at once and easily accessed.

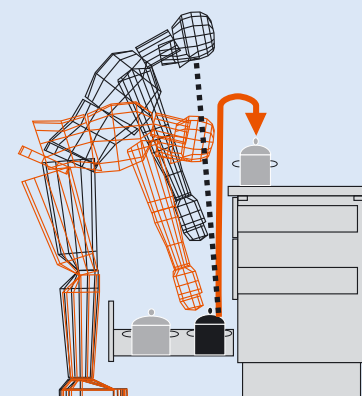

# Ease-of-use and precise alignment

**Precision positioning with just the turn of the hand, thanks to the innovative tilt and height adjustment feature for furniture fronts.**

Using the TANDEM front tilt adjustment in the TANDEM plus full extension, precise alignment between the drawer front & carcass is ensured. This is a quick & easy procedure, requiring no tools.

Height adjustment is just as easy. The height can be adjusted up to 3 mm without the need for tools. This provides a simple and precise way to adjust the front spacing on your furniture.

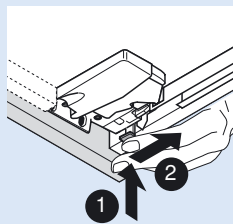
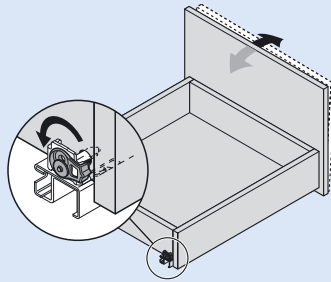

**The TANDEM locking device makes drawer insertion and removal very easy with just the turn of the hand.** This saves assembly time and provides your customers with additional ease-of-use, e.g. for cleaning. The locking device also serves as a lift-off stop.

Because of its special design, the TANDEM locking device incorporates a degree of tolerance compensation for the wooden drawer (length & width).

# TANDEM ordering information

BLUMOTION can now be integrated into TANDEM pull-outs. No need to order a separate component.

You will find suitable ORGA-LINE inner dividers in our current catalogue.

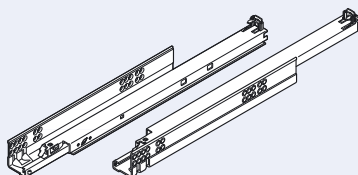

TANDEM runner:	Single extension		Full extension		TANDEM plus BLUMOTION	TANDEM plus BLUMOTION
	TANDEM 30 kg *	TANDEM BLUMOTION 30 kg	TANDEM plus 30 kg *	TANDEM plus BLUMOTION 30 kg		
Nominal Length	Part No.	art No. P	Part No.	art No. P	Part No.	Part No.
250 mm			560H2500C	560H2500B		
270 mm	550H2700.03	550H2700B	560H2700C	560H2700B		
300 mm	550H3000.03	550H3000B	560H3000C	560H3000B		
320 mm			560H3200C	560H3200B		
350 mm	550H3500.03	550H3500B	560H3500C	560H3500B		
380 mm			560H3800C	560H3800B		
400 mm	550H4000.03	550H4000B	560H4000C	560H4000B		
420 mm			560H4200C	560H4200B		
450 mm	550H4500.03	550H4500B	560H4500C	560H4500B		566H4500B
480 mm			560H4800C	560H4800B		
500 mm	550H5000.03	550H5000B	560H5000C	560H5000B		566H5000B
520 mm			560H5200C	560H5200B		566H5200B
550 mm	550H5500.03	550H5500B	560H5500C	560H5500B		566H5500B
580 mm						566H5800B
600 mm	550H6000.03		560H6000C	560H6000B		566H6000B
650 mm	550H6500.03					566H6500B
700 mm						566H7000B
750 mm						566H7500B

\* Can be combined with TIP-ON

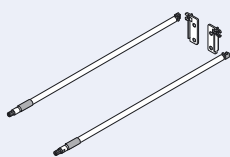

## Lateral gallery set

Nominal Length	Part No.
400 mm	ZRE.363A.ID
420 mm	
450 mm	ZRE.413A.ID
480 mm	ZRE.443A.ID
500 mm	ZRE.463A.ID
520 mm	ZRE.483A.ID
550 mm	ZRE.513A.ID
580 mm	ZRE.543A.ID
600 mm	ZRE.563A.ID
650 mm	ZRE.613A.ID

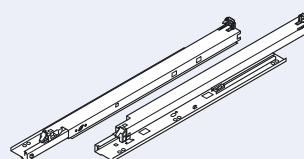

## TANDEM runner:

bottom mounting

Nominal Length	Single extension TANDEM BLUMOTION 30 kg Part No.	Full extension TANDEM plus BLUMOTION 30 kg Part No.
350 mm	550H3500BU	560H3500BU
400 mm	550H4000BU	560H4000BU

## Locking device

left/right Part No. T51.1700.04

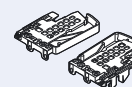

# Assembly of locking device feature

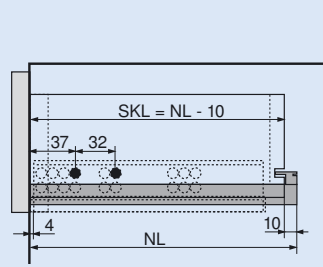

## Installation dimensions

**Drawer length (DRL)**  
 DR length = NL - 10  
 Fully exchangeable with full and single extension

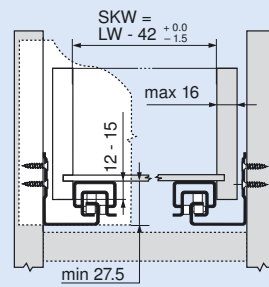

**Drawer dimensions**  
 Recess thickness 12–15 mm  
 (Exception TANDEM BLUMOTION: max.13 mm)

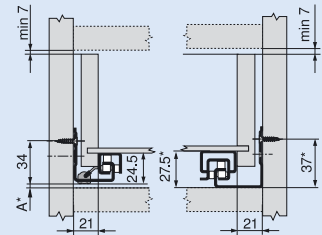

**Space requirement**  
 For full exchangeability between full and single extension, leave an additional 3 mm (dimension A)

\* + 1 mm in combination mit TIP-ON

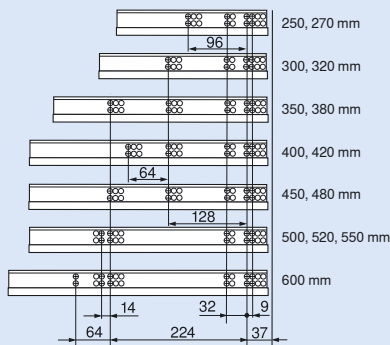

Hole pattern 560H

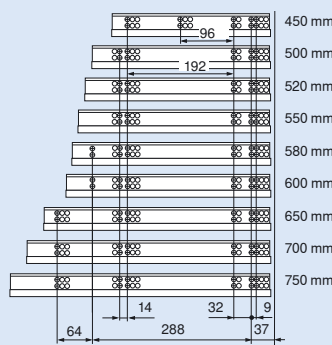

Hole pattern 566H

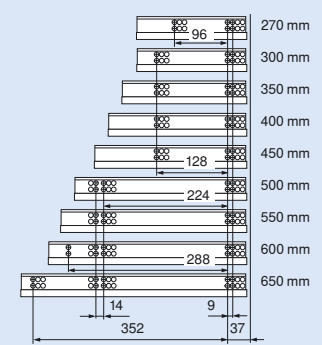

Hole pattern 550H

## Assembly

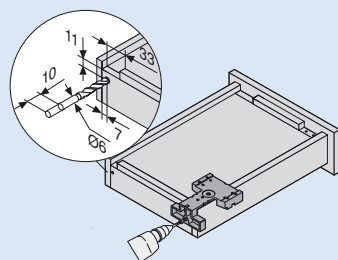

**Drawer drilling jig (Hook)**

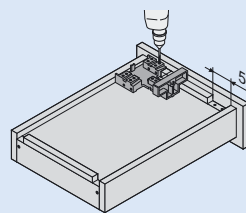

**Drawer drilling jig (Locking device)**

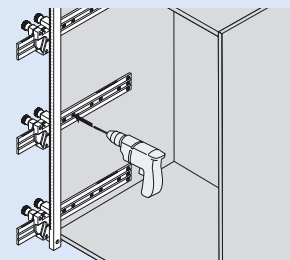

**Universal drilling template**  
 Also available as an individual template (65.1051)

Part No.  
**T65.1000.02**

Part No.  
**T65.1000.02**

Part No.  
**65.1000**



Julius Blum GmbH  
Furniture Fittings Mfg.  
6973 Höchst, Austria  
Tel.: +43 5578 705-0  
Fax: +43 5578 705-44  
E-mail: [info@blum.com](mailto:info@blum.com)  
[www.blum.com](http://www.blum.com)

 **blum**®

All content is copyrighted by Blum.  
Subject to technical modifications and changes to the range without notice.  
Printed in Austria · IDNR: 631.101.8 · EP-0874EN-AL/03.09-1